

The OFFICIAL Space Combat Guide from the top guns at



STARFOX 64

OFFICIAL
Nintendo
PLAYER'S GUIDE

STARFOX 64

PLAYER'S GUIDE

Publisher
M. Arakawa

Editor in Chief
Gail Tilden

Production Manager
Yoshio Tsuboike

Senior Editor
Leslie Swan

Staff Writers
Jason Leung
Terry Munson
Dan Owsen
Scott Pelland
Paul Shinoda

Production Coordinators
Thom Leonard
Nancy Ramsey
Paul Shinoda

Art Director
Kim Logan

Designer
Tim Garret

Strategic Layout
V Design, Inc.
Yoshi Orimo
Ritsuko Yamaji
Work House Co., Ltd.
Jumpin' Jack Yushi
Naoyuki Kayama
Hiro Ogawa
Leo Tsukamoto
Shigehiko Takahashi

**Design/Prepress
Supervisor**
Joltin' Jay Wergin

Electronic Prepress
Jessie Brown
Jim Catechi
Mark Johnson
Tanya Sharp

Prepress Assistant
Todd Dymet

Game Consultants
Tom Hertzog
Jim Wornell

Special Thanks to:
The Star Fox 64
Development Team at NCL
Takashi Watanabe/
Camel Clutch

The Star Fox 64 Player's Guide is printed in the U.S.A. and published by Nintendo of America Inc., 4820 150th Avenue NE, Redmond, Washington, 98052, at \$11.00 in the U.S.A. (\$15.50 in Canada). © 1997 Nintendo of America Inc. All rights reserved. Nothing that appears in the Star Fox 64 Player's Guide may be printed in whole or in part without express written permission from Nintendo of America Inc., copyright owner. Nintendo is a registered trademark of Nintendo of America Inc. Star Fox 64™ © 1997 Nintendo.

THE OFFICIAL STARFOX 64 NINTENDO PLAYER'S GUIDE

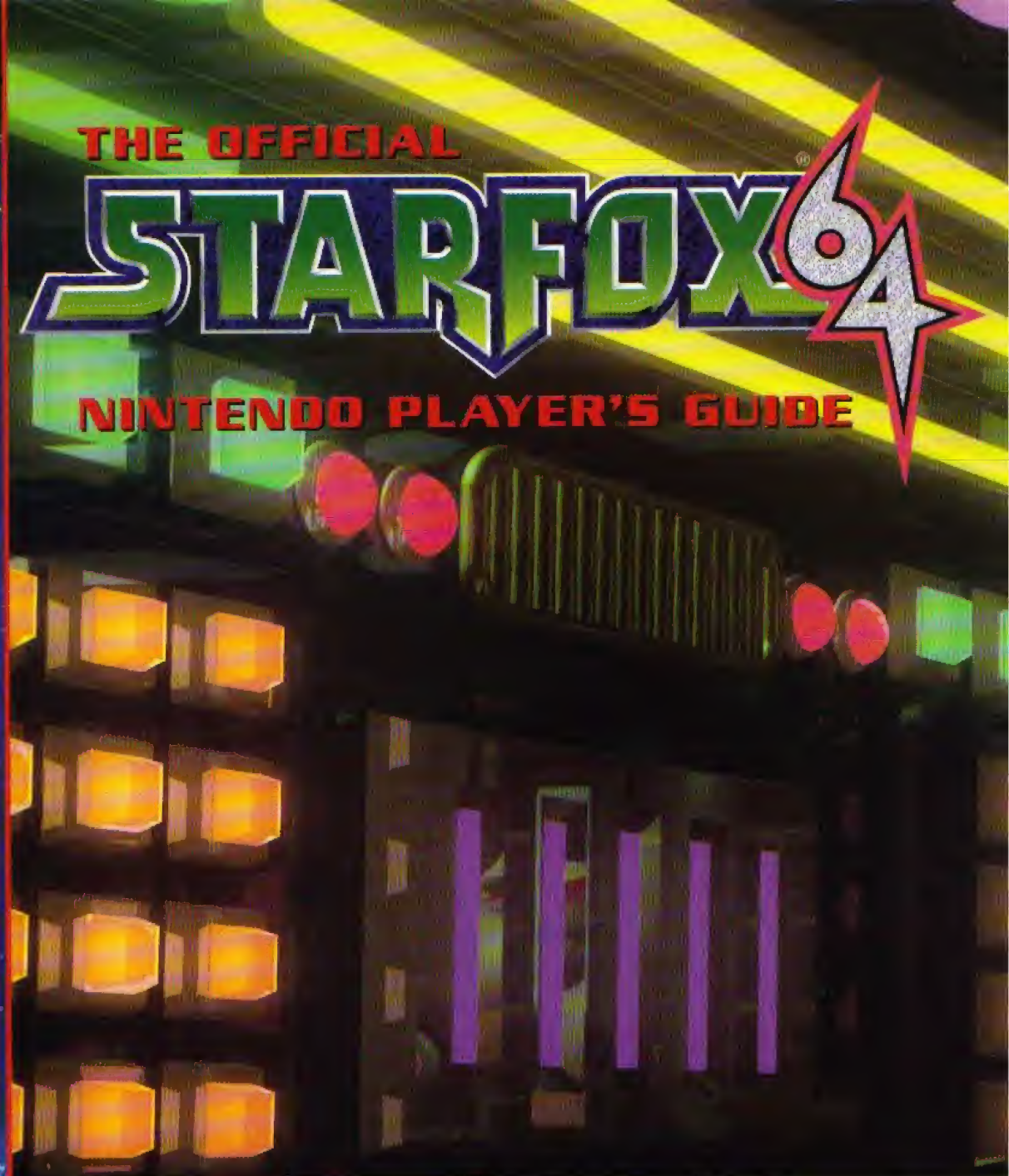



ALL PILOTS, TO YOUR SHIPS!

It's time to scramble to your Arwing fighter and take a lightspeed jump to high adventure! The evil Andross is bent on crushing the planet Corneria and reshaping the Lylat System with his twisted biotechnology. As Fox McCloud, you must lead your daring team of star pilots into the heat of battle to restore order and freedom across the system. That might be a tall order for a rookie fresh out of the Cornerian Flight Academy, but we've downloaded all the top tips, tricks and battle tactics into this, the official Nintendo Star Fox 64 Player's Guide. This guide may mean the difference between space case and space ace!

STARFOX 64





CONTENTS

Star Fox Saga	4
Star Fox Team	6
Star Fox Who's Who	8
Operations Manual	10
Items & Ordnance	16
The Lylat System	18
 Corneria	26
 Meteo	34
 Fortuna	40
 Sector X	44
 Titania	50
 Bolse	56
 Sector Y	60
 Katina	66
 Solar	70
 Macbeth	76
 Aquas	84
 Zoness	90
 Sector Z	96
 Area 6	100
 Venom	106
Vs. Mode	114
Mr. Miyamoto on Star Fox	116
Top Secret File	120

RUMBLINGS OF WAR

Five years after exiling Andross to the ravaged planet of Venom for his crimes against Corneria, General Pepper receives disturbing reports of new biotechnology experiments taking place on Venom. A team of three agents penetrates the defenses of the planet, but Pigma Dengar betrays his colleagues, James McCloud and Peppy Hare. Only Peppy escapes the trap to return to Corneria where he warns General Pepper of the treachery of Pigma and the growing danger from the exiled mad ape. As the evil hand of Andross stretches

from Venom across the Lylat Solar System toward Corneria, it

seems that all may be lost. The forces of Corneria are no match for the hatred of Andross and his vile creations. World after world falls to the forces of Venom until only Corneria stands free. At last, General Pepper makes the decision to contact Fox McCloud, the son of James McCloud, who now leads the Star Fox team. It is the last chance and the final hope for Corneria.

Without hesitation, Fox and his colleagues sign on with the Cornerian Air Force commanded by General Pepper. (Besides, they need plenty of cash to pay off the loan on the Great Fox mother ship.) These mercenary warriors represent the finest pilots and fighters in the Lylat System: Fox, the leader, Peppy Hare, the grizzled campaigner, Falco Lombardi, the brash but courageous lieutenant, and Slippy Toad, the mechanical wizard.



Only the Star Wolf team, which is controlled by Andross, has comparable skills. Now that Andross's siege of Corneria has begun, only the Star Fox team remains free to counterattack from its base aboard the Great Fox. But this will be just the beginning of the battle. They must find a way to reach Venom itself and end the madness at the source. Along the way they will encounter the horrific creations of Andross on fifteen worlds, and they will employ every high-tech weapon and secret tactic that they possess. Above all, they must fight as a team if they hope to reach the end of their mission.

Andross must be defeated at any cost, and the cost may be very high.

**PAYBACK
BEGINS
NOW.**

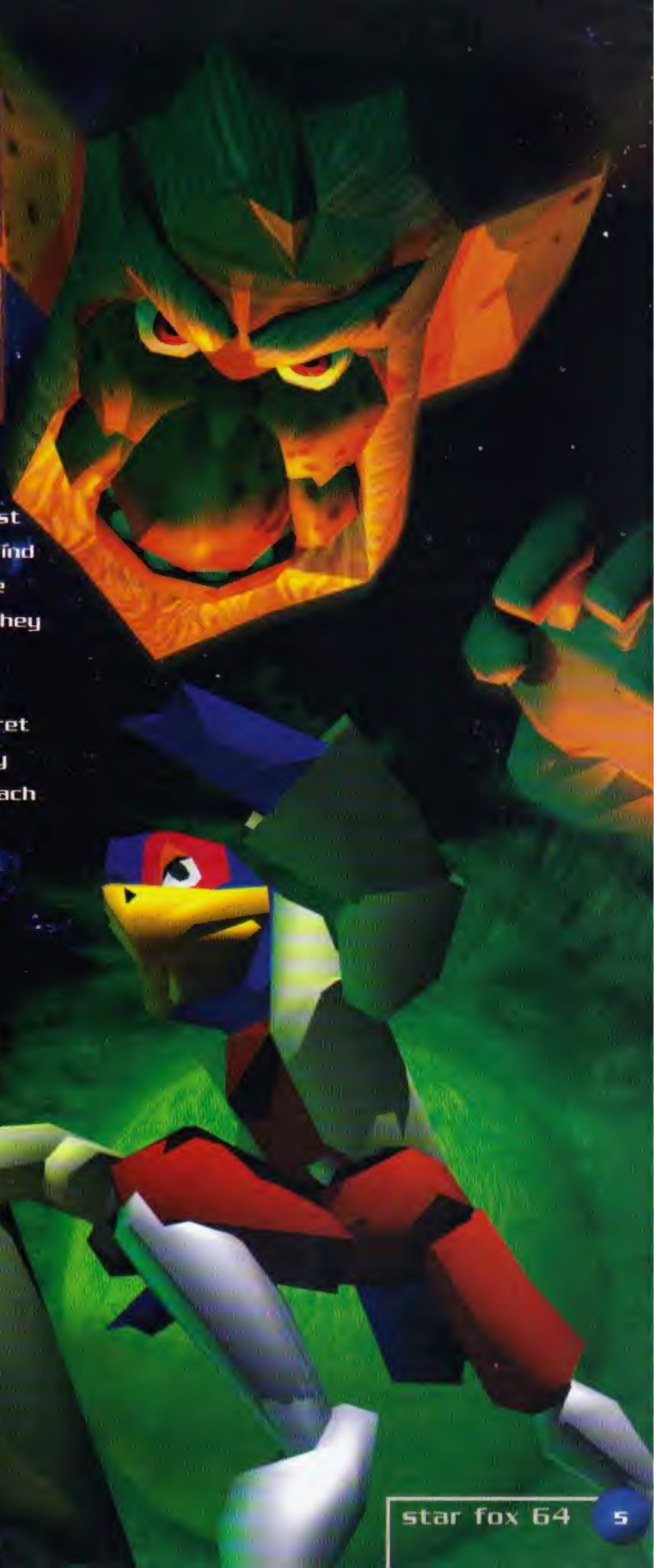

THE STAR FOX TEAM

Each of the four courageous members of the Star Fox team plays a central role in your mission to defeat Andross. You don't fly alone into enemy territory. Instead, you go with your three wingmen, Peppy, Falco and Slippy. It is vital that you lend them assistance when required to keep the team intact.



CHANNEL OPEN

Keep your eyes and ears open at all times. Your wingmen will often point out a foe's weakness, uncover a hidden path or give you vital clues to the survival of the Star Fox team. Though you may not like to be interrupted in the heat of battle, your wingmen wouldn't do it without good reason.

PEPPY HARE

Peppy's career in the Star Fox team began long ago when Fox's father, James McCloud, led the fearless fliers. Although he's a bit crusty, Peppy is a steady companion who is loyal to the core and fierce in battle. He is a source of wisdom, so pay attention when he makes a suggestion.



SLIPPY TOAD

Slippy Toad brings enthusiasm and mechanical know-how to the team. As a flyer, though, he leaves something to be desired. In fact, he seems to get in trouble whenever you let him out of your sight. But it's better to have him along, in spite of his failings.

MECHANICAL WHIZ

Slippy will route sensor scans of major foes through Great Fox's computer. Once the scans are complete, the enemy's Shield Gauge will be displayed.



FOX McCLOUD

The young leader of the Star Fox team lost his father to the evil machinations of Andross and Pigma Dengar. He has vowed to destroy Andross with the help of his friends. Fox has proven his skill as a pilot in space and on the ground, but this will be his greatest test.



MAYDAY

FRIEND IN NEED

When one of your wingmen sends out a mayday, you'd better answer the call. You'll have to trust each other and watch each other's backs if you expect to succeed against Andross and his cruel hordes. If all of you are alive and well at the end of a mission, you may qualify for a medal from the Cornerian Air Force (see pages 19 through 22 for more relevant data files). In addition, saving one of your wingmen may be part of a secret mission or may help open up a new path for you to explore.



Answering a distress call may be annoying at times, but your wingmen will return the favor many times over.

FALCO LOMBARDI

Falco specializes in flying rings around his foes, but he takes more chances than most pilots and, sometimes, he pays dearly for his brashness. Falco never quits, but he complains constantly. He has a lot to gripe about now.



FRIEND IN DEED

Falco's hunting instincts will serve you well in the coming battles. He may be hot-headed and brash, but you can trust his advice. Follow his combat and navigational suggestions.



STAR FOX WHO'S WHO

No war is just about tactics. It's about the people who become embroiled in the monumental events that lead up to battle. In the Lylat System, the main characters fall into two camps: the Cornerians and the forces that support Andross. Some of the relationships may surprise you.

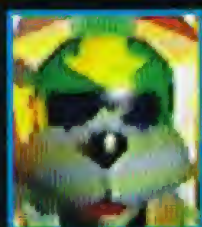
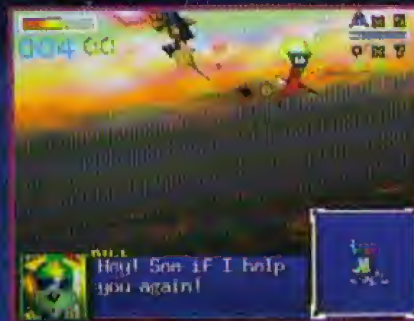

BILL GREY

Bill, Fox's best friend from the Academy, is a squadron commander in the Cornerian Air Force. You'll meet up with him on Kalina, at Solar and in Sector X.

COMMANDER



GENERAL PEPPER

The commander in chief of the Cornerian Air Force, General Pepper still feels guilty that he sent James McCloud to his doom. Now that he has hired Fox, he feels responsible for the young flyer's future.

CORNERIAN AIR FORCE

SCHOOLMATES

FOX McCLOUD

SON

SLIPPY TOAD

STAR FOX TEAM

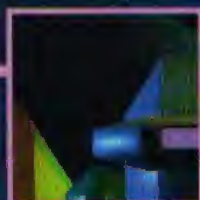

ROB 64

ROB 64, the robotic navigator aboard Great Fox, considers Slippy its best friend, probably because Slippy regularly recharges ROB's proton packs.

TREACHERY

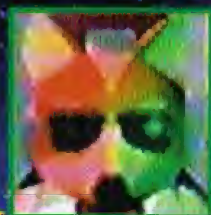

JAMES McCLOUD

Once the leader of the Star Fox team, James was betrayed by Pigma Dengar on Venom. His son, Fox, can't believe that his father is truly gone.

STAR WOLF TEAM

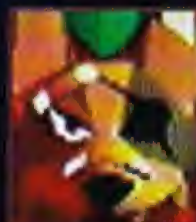

WOLF O'DONNELL

Wolf, the leader of the mercenary Star Wolf team, would like nothing more than to see Fox McCloud fail.

FATHER

FORMER COMRADES



PIGMA DENGAR

Pigma Dengar used to fly with the Star Fox team, but he sold out his comrades for money and turned to evil.

PEPPY HARE



LEON POWALSKI

Leon the chameleon is a master of disguise and cunning tactics. No one knows where he comes from, but one thing is for sure: Leon loves to inflict pain and mayhem wherever he goes. He is second only to Wolf as a flyer.



ANDREW DIKONNY

Andrew, nephew of Andross, is not much of a flyer or a fighter. His favorite book is *The Apes of Wrath*.

NEPHEW

UNCLE

DR. ANDROSS

Andross's genius is matched only by his evil intentions. He dreams of the day when all beings in the Lylat System perform his bidding.



ANDROSS'S EMPIRE

FALCO LOMBARDI



KATT MONROE

Katt Monroe has a crush on Falco, but he doesn't even know she's alive. She intends to make certain that he does take notice—and soon.

ROMANCE?

OPERATIONS MANUAL

As a member of the Star Fox team, you have access to the most advanced combat craft that Cornerian science has to offer: the Arwing fighter, the Landmaster tank and the Blue-Marine attack sub. ROB 64 has prepared the following data files for you. They contain complete technical readouts for each vehicle, including performance capabilities, weapons and defense systems. Review them carefully.



Developed by Arspace Dynamics Co., Ltd., the Arwing is the most powerful air and space superiority fighter in the galaxy. With its powerful laser cannon, Smart Bomb launcher and state-of-the-art G-diffuser system, the Arwing is capable of taking on multiple enemy targets simultaneously. Andross currently uses spacecraft that are inferior to the Arwing, but recent intelligence reports indicate that he is well on his way to developing a new fighter to rival it.



HYPER LASER



The Arwing's single laser cannon may seem inadequate at first for the job at hand, but you can collect one or more Laser Upgrades while in flight to increase its power.

COCKPIT

The on-board holographic imaging system allows you to switch between two external views and an in-cockpit view while in flight. The types of views available to you will vary according to your mission profile. Press the top C Button to switch views.



WING

Your craft's wings will sweep back automatically for high-speed cruising and deploy automatically for increased maneuverability.

G-DIFFUSER

The Arwing's revolutionary G-diffuser system generates a force field that protects the ship from enemy fire and from the stresses of high-speed aerobatics.



FLIGHT MECHANICS

CORRIDOR MODE

The Arwing is an easy ship to fly, but only a truly great pilot can be expected to master it. Most missions are flown in what is called the Corridor Mode. The Arwing moves forward automatically, and you are able to maneuver up, down, left and right. You cannot, however, turn completely around.



R BUTTON AND Z BUTTON

BARREL ROLL

To perform a barrel roll, tap either the R Button or the Z Button twice. As your ship rolls, the G-diffuser generates a protective force field. This field can blunt some of the force of an enemy's attack, but it won't make you completely invincible.



If you perform a barrel roll or tilt your spacecraft on its side while turning, you'll turn more sharply than usual.



ALL-RANGE MODE

Some missions and parts of missions are flown in All-Range Mode, which places you within a large, 3-D battlefield. You have complete freedom of movement in this mode, but you'll turn around automatically if you reach the edge of the map.

CONTROL STICK

HANDLING

The Arwing's Control Stick follows the standard military pattern for air- and spacecraft operation. To dive down, push Up on the stick. To gain altitude, press Down.



TILT

Press and hold R or Z to tilt the Arwing on its side. This position will make it easier to slip through tight spaces.



C BUTTONS

BOOSTER AND BRAKES

Press the left C Button to activate the booster and press bottom C to deploy the air brakes. The Boost Gauge in the upper right corner shows available booster and brake power. An all-blue bar means it's fully charged.



LOOP

Press Down and the left C Button to perform a loop. This works in Corridor and All-Range Mode.

U-TURN

Press Down and bottom C to perform a U-turn. You can U-turn in All-Range Mode only.



WEAPONS SYSTEMS



Advanced propulsion systems and spaceframe design give the Arwing superior atmospheric and space flight capabilities, but they're only part of the reason this ship is so successful in combat. The Arwing's weaponry represents the cutting edge in Cornerian military technology, giving this formidable fighter the equivalent firepower of a front-line space cruiser.

HYPER LASER

Your ship comes off the assembly line with a single laser cannon, but Laser Upgrades will increase its power. Collect one upgrade to change the single laser to a twin laser. Collect a second upgrade to change them into hyper lasers. You can tell when you have hyper lasers by the telltale sound they make. If your ship takes heavy damage, it will revert back to a single laser. Laser Upgrades are often hidden within enemy ships and gun emplacements. You often must destroy an entire squadron or group of guns before they will appear.



Laser Upgrades are carried over from one mission to the next. If the Arwing is destroyed, you'll lose all your Laser Upgrades and any other items you collected.



LOCK ON

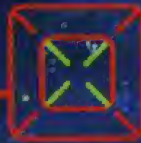

CHARGE & LOCK

The hyper laser also has the ability to store up and fire a concentrated blast of energy. Press and hold the A Button to charge the laser and then tap A to fire. To "lock on" to an enemy, aim at a specific target while the laser is charging. When you fire, the laser bolt will home in on the target. The resulting explosion can wipe out entire groups of enemies.



Once you lock on to a target and fire a charged laser blast, you can't lock on again until that blast has detonated. You can still fire regular and charged lasers in the meantime.

SMART BOMB

The Smart Bomb can also track a specific target, but you must lock on to it first. If you fire a bomb without a target lock, it will fly straight ahead until it hits something or until its built-in timer runs out. You can't lock on to major enemies, but a bomb can still be very effective against them. You can also detonate a bomb manually by launching it and then pressing B.



The bomb packs a much bigger punch than the laser. A single bomb can easily take out half of a major enemy's protective shields.

MASTER PILOTING TECHNIQUES



There are numerous items hidden throughout your missions. Besides destroying groups of enemies, you can try flying through several gates, arches or rings in a row to reveal them.



Keep an eye on your radar while in All-Range Mode. If you see an enemy on your tail or see his lasers blazing past you, pull a loop and drop in behind him or make U-turn to escape.



In All-Range Mode, tilt or pull a barrel roll while turning to bank more sharply. Hitting the brakes will also sharpen your turn. Most enemy ships can't match your maneuverability.



TACTICAL VIEWS

In most Corridor Mode missions, you can choose between a view from behind your ship and a view from within the cockpit. In All-Range Mode, you have a choice between a close-up and a wide-angle view from behind your ship.

The wide-angle view is usually much better for spotting enemies chasing you.



It's important to choose the view that you're most comfortable with. You must decide whether to focus on what's dead ahead or on what's going on around and behind you.

ROLLING THUNDER

The Landmaster tank shares many hull pieces with the Arwing, so it's not surprising that they look much alike. More important, however, are the similarities that they share beneath their armored skins. The Landmaster uses many of the same propulsion and weapon components as the Arwing (including the G-diffuser unit), adapted for use in a ground-based vehicle. Though some space jockeys will always prefer flying over driving, they must admit that the Landmaster gives you the same firepower and flexibility planetside that the Arwing gives you in the air and in space.



LASER

The Landmaster has a single laser that can fire rapidly or charge up for a concentrated blast.



BOMB

The Landmaster also boasts a Smart Bomb launcher. Lock on to a target first for best results.



ROLLING

The Landmaster can barrel roll much the same way the Arwing can. This maneuver is key to avoiding air-to-ground laser fire and other attacks. Tap R or Z twice to start rolling.

ALL-TERRAIN TECHNIQUES

HOVER

Though the Landmaster doesn't have true flight capabilities, it can hover over short distances. Press and hold R and Z to fire all thrusters. Steering while hovering can be tricky.



TILT

Press and hold R or Z to fire a single thruster and make the Landmaster tip slowly. This can help you climb over low obstacles.



LANDMASTER

CANNON

The Landmaster's laser is more powerful than the Arwing's base weapon. The main gun can't be upgraded, but it can charge up and lock on to targets.



G-DIFFUSER

A lot of power is used to hold the hull together, so the G-diffuser won't generate an extra shield when you roll.

AQUATIC ARMAMENTS

FATHER AND SON

Slippy's father, Beltino Toad, is Director of Engineering at Arpace Dynamics, and together they have adapted the Arwing's components for use in an aquatic vehicle. The impressive result is the Blue-Marine attack sub. The Blue-Marine has not yet been approved for mass production, but while there is only the one prototype in existence, it will be made available for your use in the coming battle.



The Blue-Marine packs a heavily modified laser and a Homing Torpedo launcher. The laser can't be charged up, but you have an endless supply of torpedoes, so you need not worry about using them up. The torpedoes glow brightly, and they may be your only source of light in deep water.



ROLLING



Like its sister ships, the Blue-Marine can also barrel roll with a couple of quick taps on the R Button or the Z Button.

TORPEDO TUBE

The Blue-Marine's torpedo launcher uses top-secret technology to generate its own supply of ammunition.



ADVANCED AQUABATICS

TRIPLE THREAT

If things get too crowded in the deep blue, your best defense will be a strong offense. Tap the A, B and the R or Z Buttons rapidly to fire the laser, launch torpedoes and barrel roll simultaneously. This is the best tactic for protecting yourself and racking up hits.



BLUE-MARINE

G-DIFFUSER

Recent advancements in G-diffuser design have resulted in a more compact unit capable of generating much stronger force fields. Testing on it continues.



ITEMS & ORDNANCE

While the Arwing and its siblings are very powerful, they do require regular maintenance. You can find various repair items, weapon upgrades and extra ammunition in battle. Shield Rings, smart bombs and upgraded lasers are carried over to the next mission. If you manage to upgrade your shields, the effect will last for that mission only, and they will reset back to normal at the start of the next.



CALL FOR BACKUP

ROB 64 will sometimes contact you via sub-space radio during battle. When you hear a chime and see a yellow icon flash, press the right C Button to open a channel. ROB will send you a Supply Container with an item in it. To find other items and identify strategic points in each mission, refer to the battle maps on the following pages. The chart below is a key to the icons on the maps and tactical readouts.



Shoot the Supply Container to open it. The item or upgrade you receive often depends on the condition of your ship.

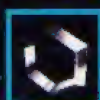

SUPPLY RING

The Supply Ring partially recharges your Shield Gauge.

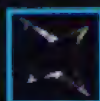

SUPPLY STAR

This gives you more shield energy than the Supply Ring.

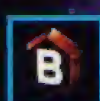

SMART BOMB

A Smart bomb adds one bomb to your reserve, up to a maximum of nine.

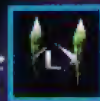

LASER UPGRADE

Collect this to upgrade to a twin laser or hyper laser.



MAYDAY

Look for these on the battle maps to see where your wingmen will need assistance.



SHIELD RING

Collect three to increase your shield capacity and three more to earn an extra ship.



LOCK ON

This icon indicates places where a lock on would be helpful to down groups of enemies.



CHECKPOINT

Fly through the Checkpoint to save your progress in a mission and get a shield recharge.



EXTRA SHIP

Check your battle maps carefully to see where you can collect this extremely rare item. It adds one ship to your inventory.



WINGS REPAIR

As your Arwing takes damage, its wings and Laser Upgrades may be lost. It will also be harder to control. You can collect this to repair the damage, but you won't regain Laser Upgrades.

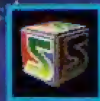

SUPPLY CONTAINER

The item within the container will usually be something you really need at the time.



LYLAT DATALINK

ROB 64 has downloaded interesting information from various databases around the system.



DETOUR OF DUTY

Check this datalink for info on secret missions. By completing these missions, you will open up new paths through the Lylat system.

GREAT FOX

MAIN BRIDGE

This is the nerve center of this magnificent craft. ROB 64 will monitor your progress via the ship's sensors.

DOCKING BAY

If your teammates' ships are badly damaged, they'll return here for repairs and a refit.



ARWING

SPACE SUPERIORITY FIGHTER

Length: 18.5 sm

Height: 5.5 sm

Maximum Speed:

M 4.2 (in atmosphere)

Engine:

NTD-FX1 plasma engine w/G-diffuser

Armament:

T&B-H1 laser cannon (1)

Smart Bomb launcher (1)

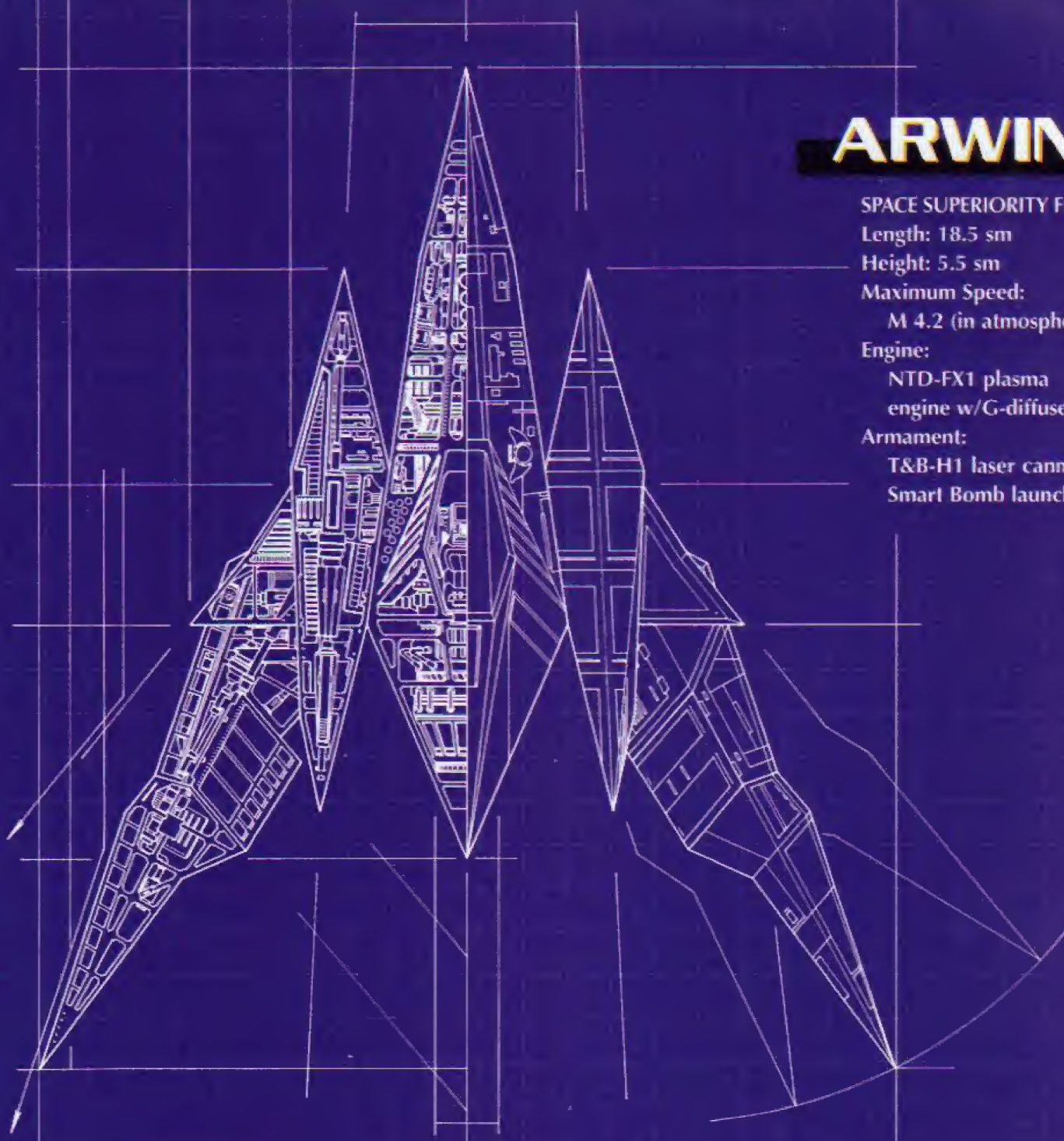

Comments:

Developed by Arspace Dynamics Co., Ltd. under exclusive contract. Because of the complexity of its components, most notably the G-diffuser system, the Arwing is not yet slated for full production. Four prototypes have been made available to the Star Fox team for flight and combat testing.

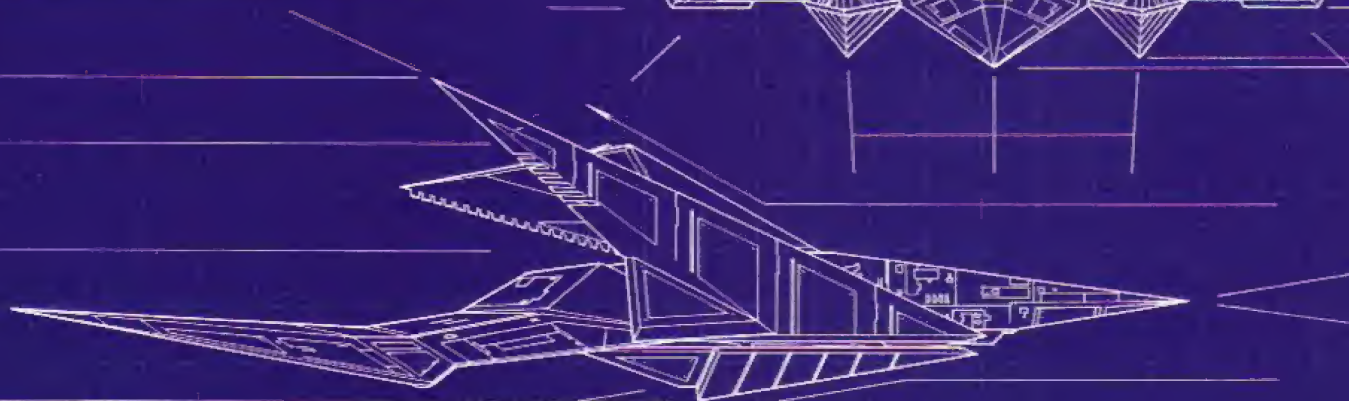
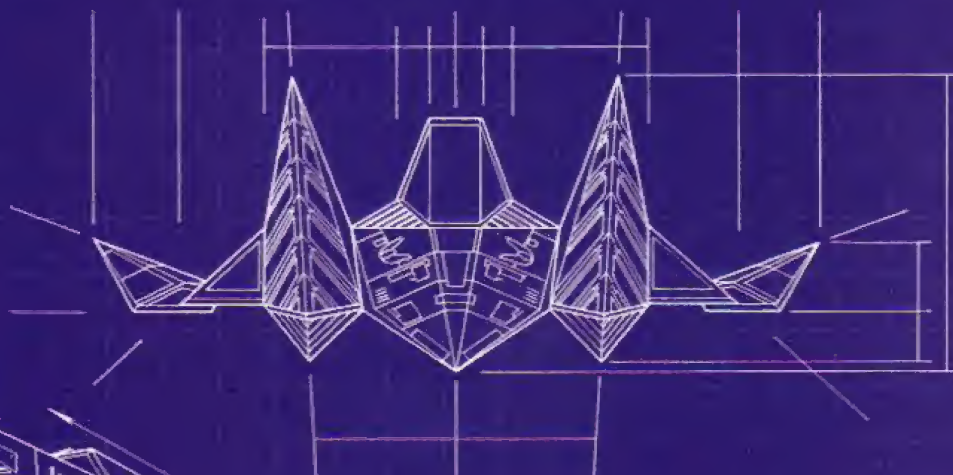

LANDMASTER

HEAVY ASSAULT TANK

Length: 17.5 sm

Height: 8.5 sm

Maximum Speed: 207 skm/h

Armor:

.65 sm front/rear

.45 sm sides

Armament:

T&B-J2 laser cannon (1)

Smart Bomb launcher (1)

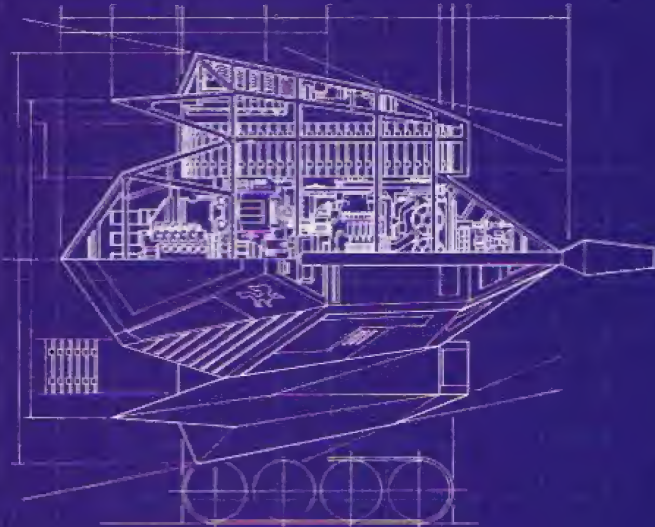
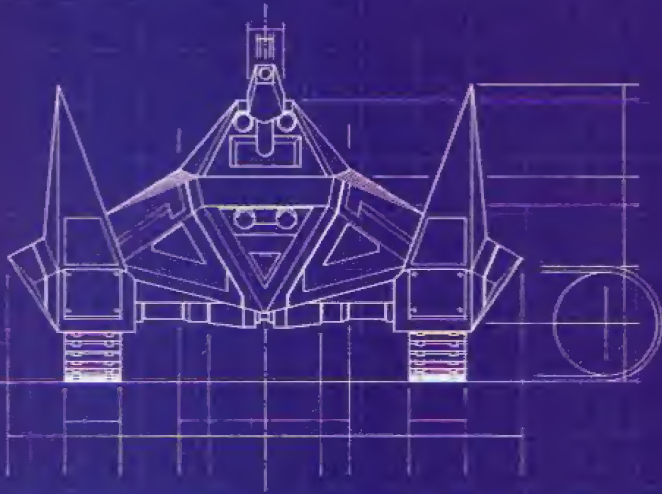
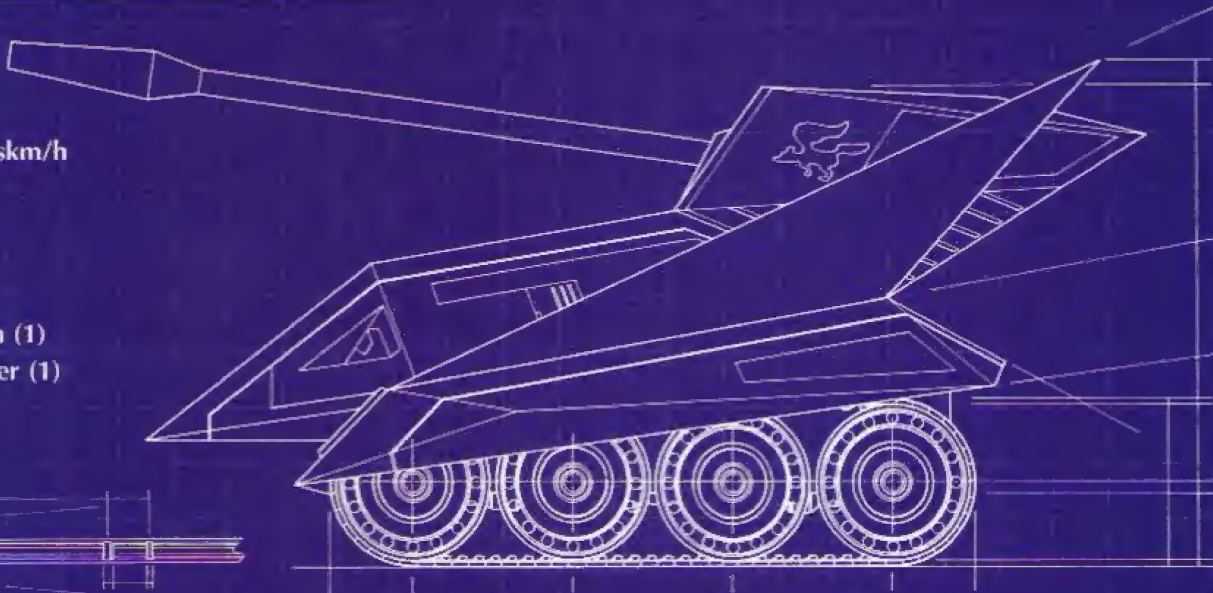
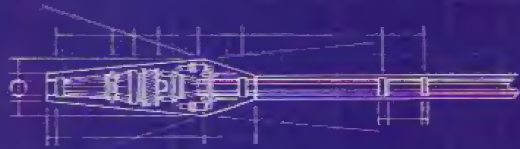

TECHNICAL SPECIFICATIONS

BLUE-MARINE

ATTACK SUBMARINE

Length: 16.5 sm

Height: 7 sm

Maximum Speed: 116 skt/h

Maximum Dive: 2,000 sm

Armament:

T&B-U3 laser cannon (1)

Homing Torpedo launcher (1)

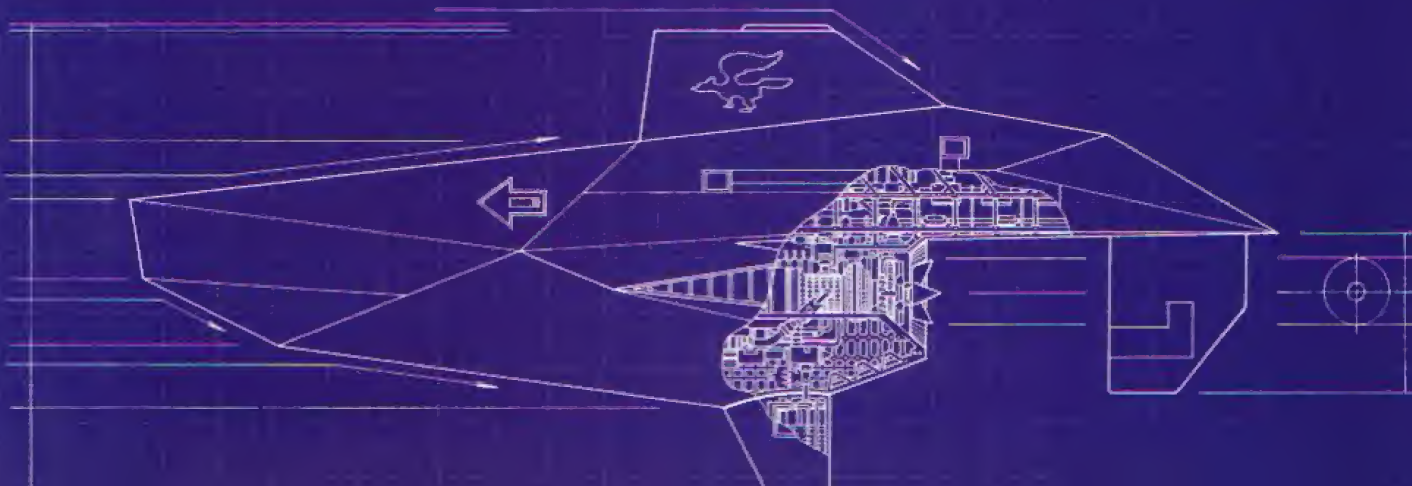

Comments:
Both the Landmaster and the Blue-Marine use propulsion system components originally developed for the Arwing. All three can synthesize their own hydrogen fuel for their plasma engines, giving them extended operating ranges.

STARFOX 64





MISSION ROUTE PLANNER

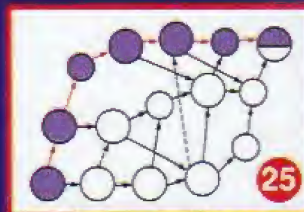
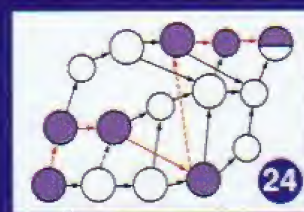
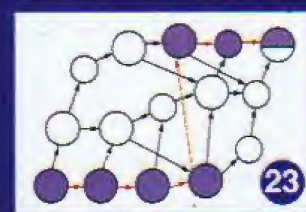
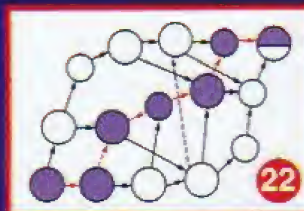
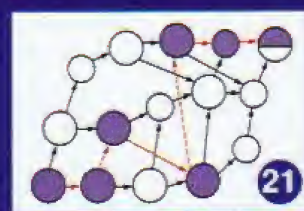
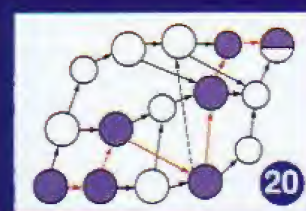
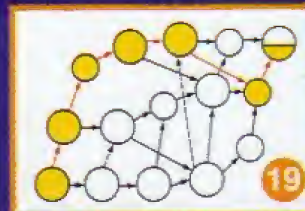
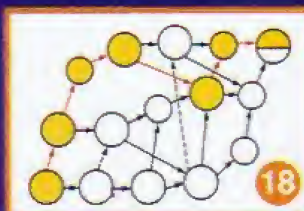
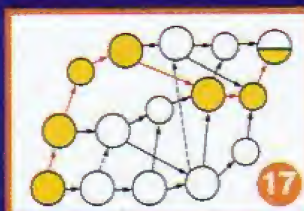
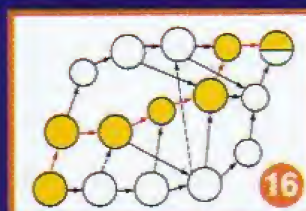
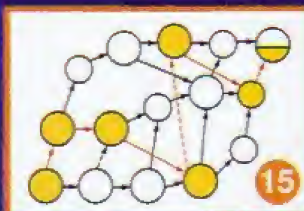
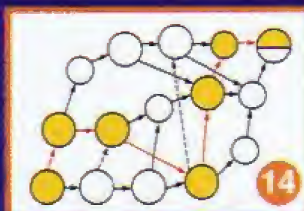
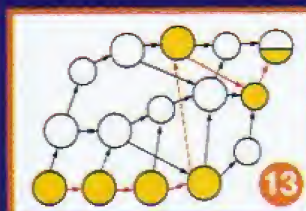
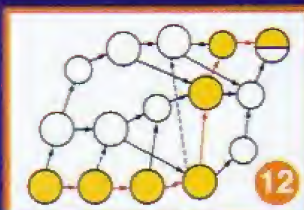
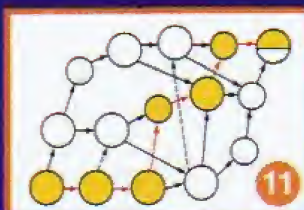
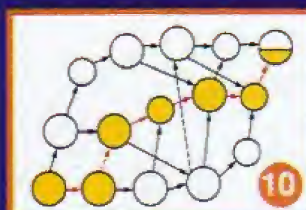
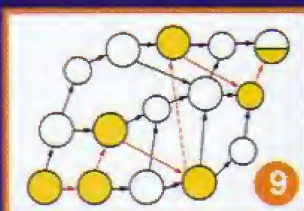
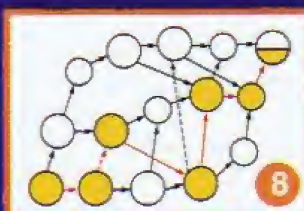
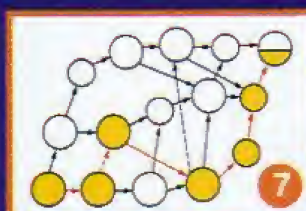
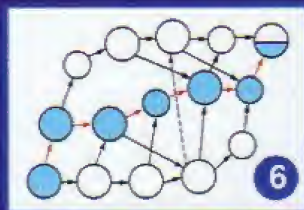
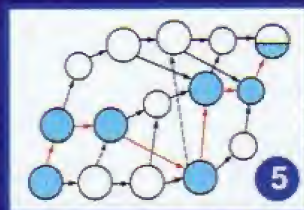
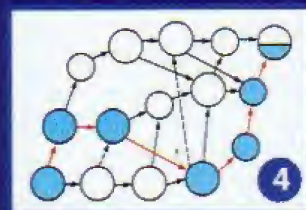
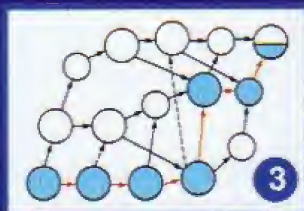
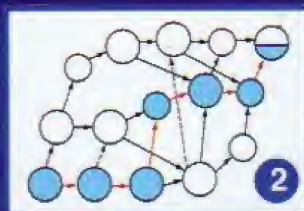
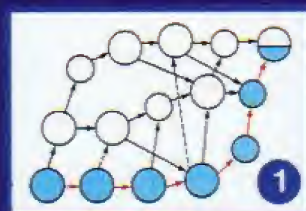

Easy Routes

If this is your first time in an Arwing, you might take one of the easier routes to Venom. There's plenty of challenge, but you won't have to complete many secret missions or use the warp routes, marked by the dotted lines.



Medium Routes

According to Cornerian military strategists, routes 7 through 19 offer a lot more challenge, peril and reward for the experienced star pilot. Some involve using the warps in Meteo and Sector X.

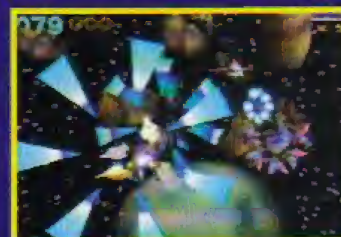

Hard Routes

Routes 20 through 25 include the toughest challenges that the evil Andross can throw at you, and fulfilling secret missions will be the order of the day. Only master star pilots need volunteer.



CUSTOM ROUTES

Our military strategists have designed a flexible battle plan to give you the freedom to choose missions and set goals according to your preferences. Here are some intriguing variations to consider.



THE SHORT AND LONG OF IT

QUICK ROUTE

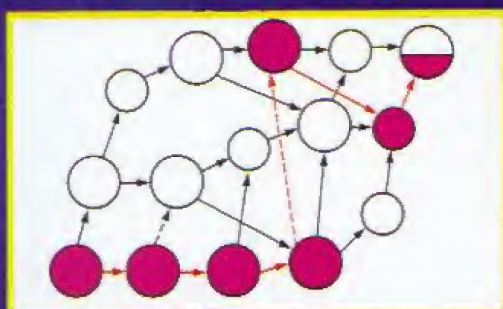

Route 13 is designed to shut down Andross with a minimum commitment of time and resources. This is the quick and dirty way to get the job done.

LONG ROUTE

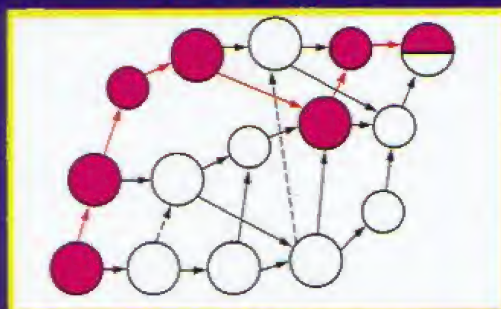

This route, 18, takes advantage of your superior skills and vehicles. It takes you to the bigger, tougher missions to inflict the most damage possible.

SAFETY ROUTE

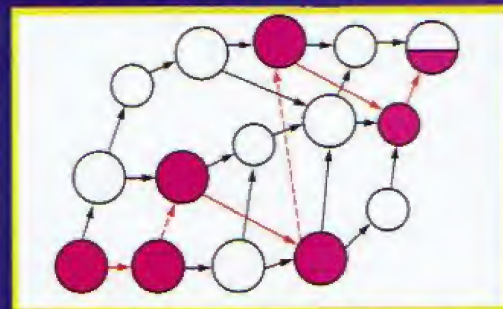

Route 9 takes you to Venom along the path of least resistance. If you're fresh out of pilot training, this just might be the route for you.

MINIMUM HITS

Invoice

Cornerian Army Attn: Gen. Pepper
Payment due for services rendered

Venomian units destroyed: 35

Total amount due: sp\$ 2240



The longer you take to defeat major enemies, the fewer hits you score. This is about the smallest number of hits you can score and still win the war.

MAXIMUM HITS

Invoice

Cornerian Army Attn: Gen. Pepper
Payment due for services rendered

Venomian units destroyed: 1486

Total amount due: sp\$ 95104



Route 18 also gives you the best opportunity for a high score. One of our top pilots managed to rack up this impressive score along that route.

MIYAMOTO'S ROUTE

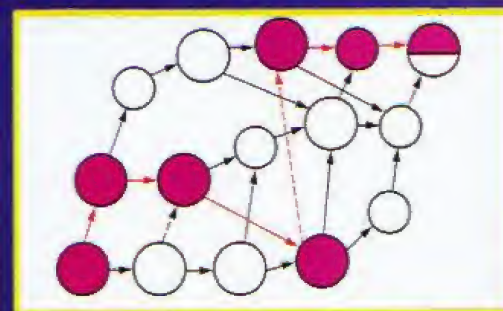

General S. Miyamoto, Chief of Staff of the combined Cornerian Expeditionary Force, has mapped out his favorite route, 24, for your consideration.

EARNING MEDALS

Though you're not a commissioned officer in the Cornerian military, you can be decorated for valor in combat. If you score a certain number of hits in a mission and all your wingmen survive, you'll be awarded a gold medal. The specific number of hits required is listed below each mission name on the navigational chart at left. You'll have your best chances for winning medals in Corneria, Aquas and Fortuna, while Sector Z, Katina and Area 6 will pose the greatest challenges.

EASY

Corneria
Aquas
Fortuna



It won't be terribly difficult to bag something for your trophy case on

HARD

Sector Z
Katina
Area 6



You'll be lucky to get out of these missions with your ship intact, much

STARFOX 64

To get from Sector Y to Aquas, you must score at least 100 hits during the mission, including the hits earned from destroying the shogun warriors and the Shogun warlord at the end of it.

The secret mission in Zoness is particularly difficult: you must destroy all of the searchlights on the planet surface. If you don't, the enemy will identify you, and your rendezvous with friendly forces in Sector Z will have to be called off.

SECTOR Y
150 HITS

AQUAS
150 HITS

ZONESS
250 HITS

The secret mission in Katina is to destroy the enemy mothership before it destroys the Katina base. If you do, you'll go on to Macbeth. If you don't, you'll continue the battle at Sector X.

To open the route to Sector Y, you must fulfill two secret missions in the battle over Corneria: save Falco from a squadron of enemy fighters and then fly through a series of stone arches.

KATINA
150 HITS

METEO
200 HITS

Shoot down all the enemy ships, including the Star Wolf team's, before a bomb destroys the Fortuna base.

CORNERIA
150 HITS

FORTUNA
50 HITS



To stay on the red route from Sector Z to Area 6, you must destroy all of the incoming space cruise missiles. If even one of them hits Great Fox, your cruiser will have to divert to the Bolse satellite, and so will you.

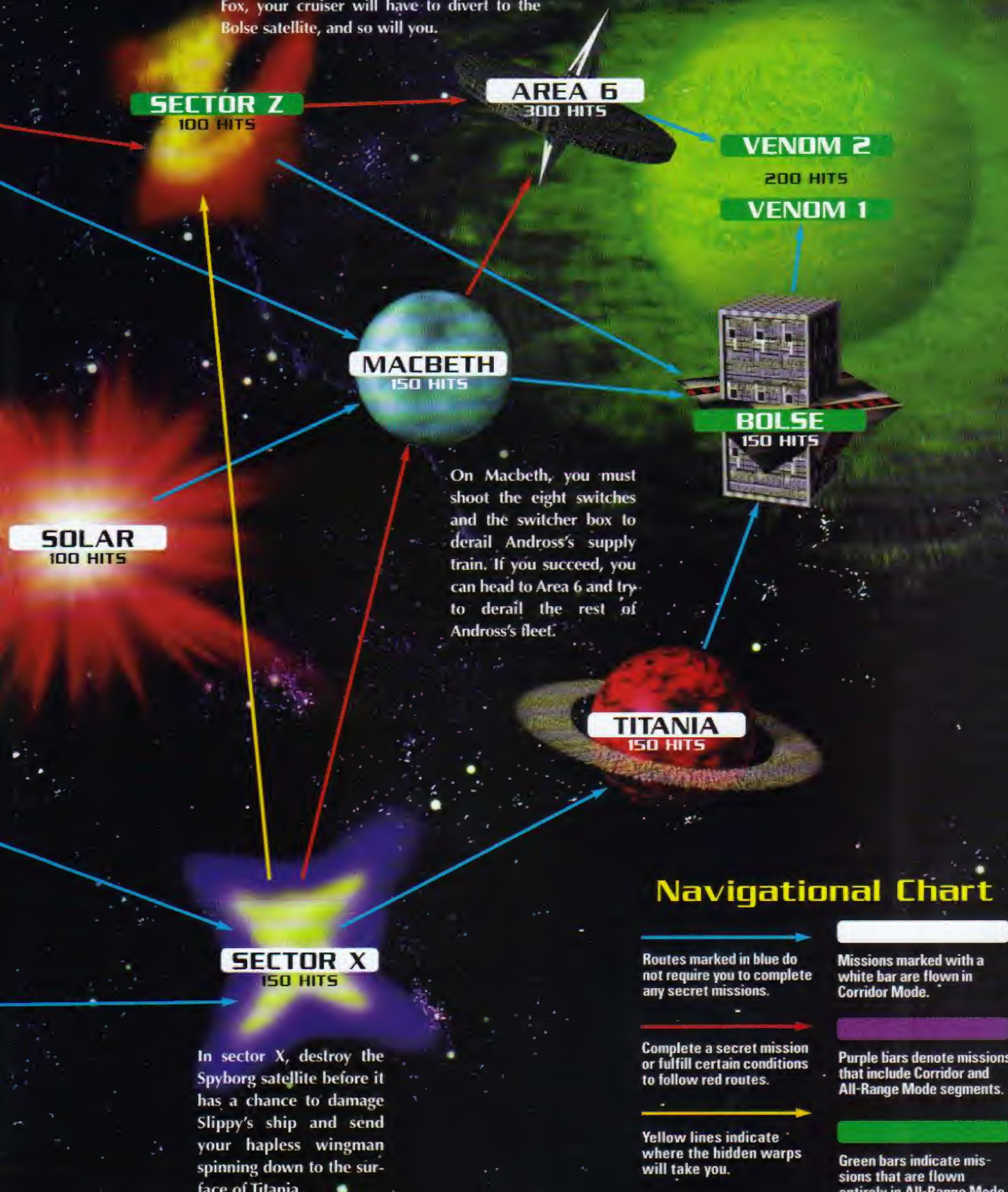

MACBETH
150 HITS

On Macbeth, you must shoot the eight switches and the switcher box to derail Andross's supply train. If you succeed, you can head to Area 6 and try to derail the rest of Andross's fleet.

TITANIA
150 HITS

Navigational Chart

Routes marked in blue do not require you to complete any secret missions.

Complete a secret mission or fulfill certain conditions to follow red routes.

Yellow lines indicate where the hidden warps will take you.

Missions marked with a white bar are flown in Corridor Mode.

Purple bars denote missions that include Corridor and All-Range Mode segments.

Green bars indicate missions that are flown entirely in All-Range Mode.

SECTOR Z
100 HITS

AREA 6
300 HITS

VENOM 2
200 HITS

VENOM 1

BOLSE
150 HITS

SOLAR
100 HITS

SECTOR X
150 HITS

In sector X, destroy the Spyborg satellite before it has a chance to damage Slippy's ship and send your hapless wingman spinning down to the surface of Titania.

MISSION GUIDE



F
L
I
G
H
T
L
O
G

Vital information to the success of your upcoming missions against the forces of Andross can be accessed only in the following pages. During each mission, you may download tactical information on the battle courses and enemies that lie ahead. You'll also learn where to find items that can power up or repair your vehicle during a mission. These maps and documents contain classified material detailing the requirements of secret missions as well as standard operations. If you are captured, the General will disavow any knowledge of your activities and the Mission Guide will automatically self-destruct. Good luck.

Mission 1

150 HITS

CORNERIA

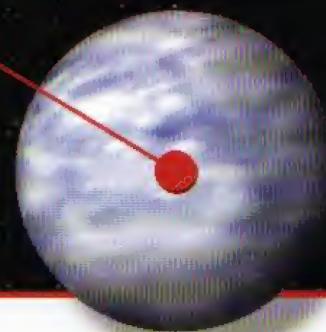

Fox, the military situation on Corneria is deteriorating! Andross's advance forces have finally breached our defenses and are assaulting the capital! We've held them back for as long as possible, but now we need your help! The main thrust of Andross's attack on Corneria is centered around the old army base in Corneria City. Approach the city through the southern canyon— this should give you the element of surprise. Take out all the fighters and ground forces. Beware of falling rubble from the buildings of the city, and watch out for berserk construction robots!

1 TO METEO CHALLENGE

By completing the Cornerian mission and destroying Granga at the end of the battle, you'll automatically move on to face the enemies amassed in the Meteo sector.

2 TO SECTOR Y CHALLENGE

If you fulfill the secret mission requirements on Corneria, you'll fly off to Sector Y instead of Meteo. Just save Falco and fly beneath the stone arches.



CRUISING CORNERIA

The armies of Venom attack Corneria with fighters, robots and tanks. General Pepper can't wait any longer. He needs the Star Fox team immediately if the planet is to remain free. The battle will rage down the length of the capital city as you fly between city towers, then over lakes and valleys. Watch out

for enemies that appear from behind and use your brakes and booster. To find secrets, look for arches to fly beneath and narrow spaces between buildings that you can fly through in your Arwing. Finally, use the lock-on technique to achieve high hit rates and wipe out entire enemy formations.



Planetary Data

● Radius.....	6,464 skm
● Albedo.....	37
● Gravity.....	1.000
● Esc. Velocity.....	12.10 skm/s
● Equilibrium K.....	279
● Atmosphere.....	N277.0221
● Hydrographics.....	75%
● Biomass.....	2,870 Quads
● Class.....	H

Planetary Compendium

The temperate world of Corneria is known as the jewel of the Lylat system. Although the planet is home to 85% of the Lylat system's population, its industry and cities are built in harmony with nature. Corneria is the center of government, culture and politics for the Lylat system.

**ENEMY RECON****Garudas**

Garuda bots roll around the city, sometimes carrying huge beams from destroyed buildings. Look for them near structures, where they are about to cause havoc. Blast them early to prevent them from destroying buildings or throwing beams at your ship. You can earn up to five hits for a Garuda.

Ski Bots

You'll encounter these mechanoids beyond the city, sliding across the lake like graceful cross-country skiers. They won't attack you, but if you hit one, you'll take damage. Lock on your lasers and blast them. Many of them ski straight across your path, but look for others at a distance.

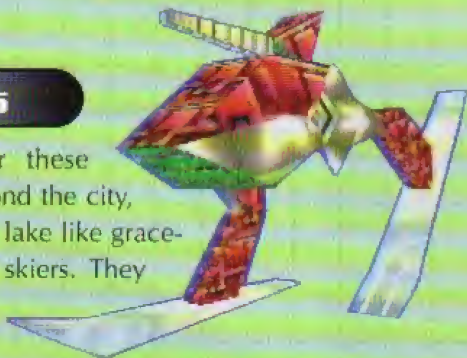
**Granga Fighters**

In the All-Range Mode when you face the boss, Granga, you'll also encounter these swift, highly mobile fighters. They follow your team members closely and can be a nuisance, but if you concentrate your attack on Granga and destroy him quickly, you'll never even notice these gnats.

**Firebirds**

If you follow Route 2, you'll encounter many of the Firebirds flapping about. They also drop egg bombs that burst into columns of scorching fire. Dodge the fire and blast the birds by locking on to them from a distance. You'll also encounter several Firebirds on Route 1 near the waterfall.

**Mole Missiles**

Beyond the waterfall in Route 1, and in the early stretch of Route 2, these green missiles shoot up from the ground and explode. They leave silver Supply Rings behind if you shoot them before they blow, so keep an eye out for these bombers from below.





LOCK ON



BANDITS FROM BEHIND

As you're heading toward the city, about to enter the narrow valley, several enemy fighters will move in behind you. Use the brake to let the enemies zip overhead. When they're in front of you, blast them.



The fourth wave of fighters on Corneria arrives in two wings—three ships from the left and two ships from the right. Lock on to them all and earn a Laser Upgrade.



Shoot the four enemy fighters that appear just as you enter the city to pick up a Supply Ring. Lock on to one and, when they're close to each other, fire!

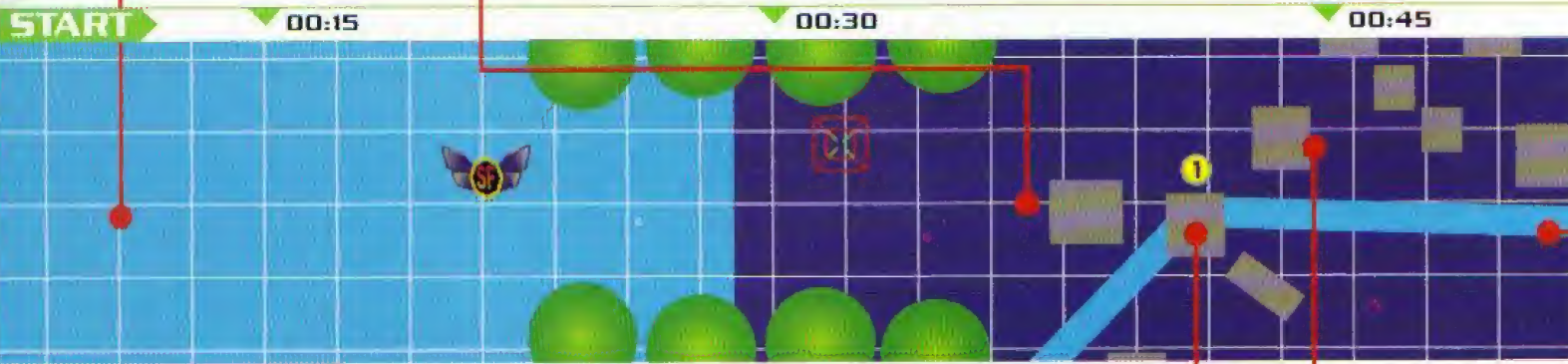

MAYDAY

Slippy is in trouble right from the start. Since only one enemy trails the frog, just get a laser lock on it and drop it into the surf below.



1 THE Z GATE

As you enter the city, dive under the arch to the right of center to pick up the gold Shield Ring. Immediately push the Z Button to bank sharply left. Shoot the doors of the building to the left so that they open, revealing a Bomb that you can pick up.

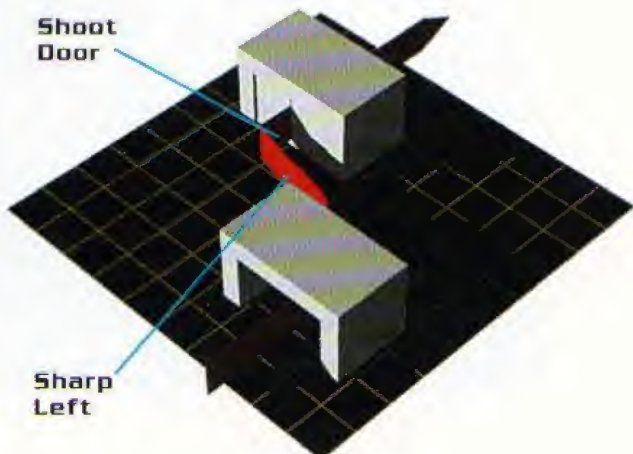

FIGHT LOG

2 BUILDING CRASHER

The giant Garuda bot will push over the tower on top of the Laser Upgrade unless you destroy the bot first. From a distance, just as the tower comes into view, push the A Button to get a laser lock on the bot. If you blast it soon enough, it won't push over the building and you can swerve left to grab the more powerful laser.



Hit the three tanks on the raised highway, then dip down for the Supply Ring in the roadbed.



Directly behind this Garuda is a bomb. Blow up the bot and fly through the empty space to pick up the Smart Bomb.



Flatten two tanks on the road and pick up a Supply Ring.

01:00

01:15 TO PG. 30

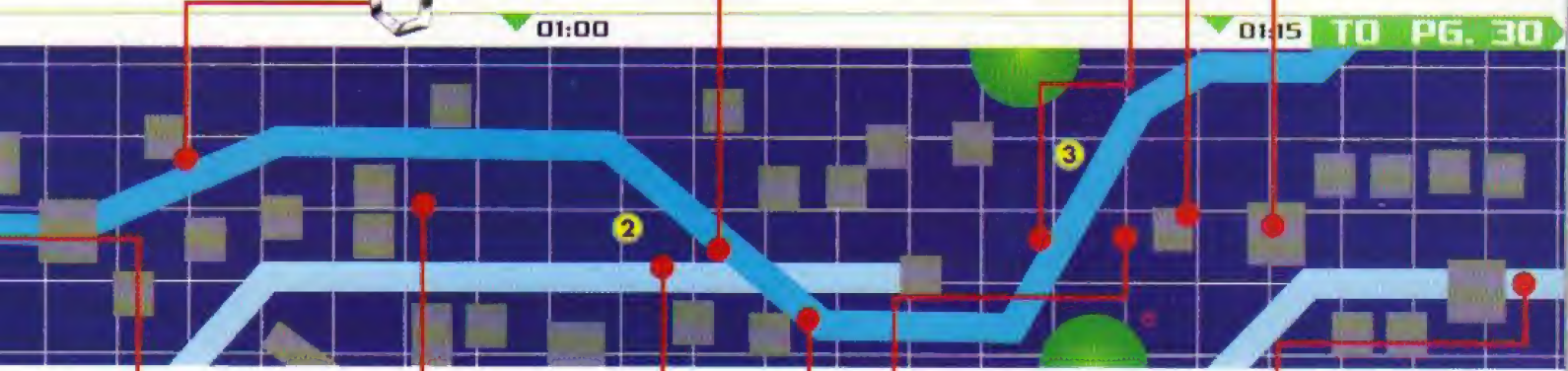

Blast these two tanks on the ground roadway to make a Supply Ring appear. They're easy to miss, so keep your eyes peeled.



You'll hear a message warning of an enemy on your tail. Brake, let it pass, then shoot it down.



Dive through this gate to pick up the Smart Bomb that appears before the Checkpoint.



Stand your Arwing on its side to slip through these wrecked buildings. Just beyond, you'll pick up a Smart Bomb.



3 BRAKE FOR GLORY



Peppy warns you that enemies are on your tail. Brake hard and let them fly by, then slap them with your lasers. The defeated fighters will leave a silver Supply Ring in their smoking debris. But more important than that is they won't be able to dog your tail anymore.

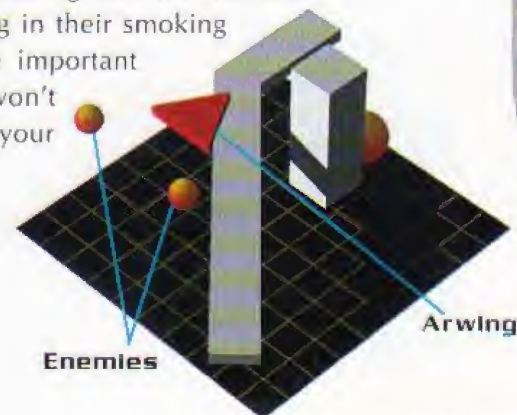

Enemies

Arwing

MAYDAY



Falco gets himself in trouble shortly after

passing the Checkpoint. Three bandits appear on his tail. Use your booster when you hear your wingman, then lock on to the bandits on the right side of the valley and take them all out at once.



On the bridge, you'll find two cannons above and two below. Get a lock to destroy three of them. Swoop down, blast the fourth and pick up the gold ring.



FROM PG. 29

01:30

01:45

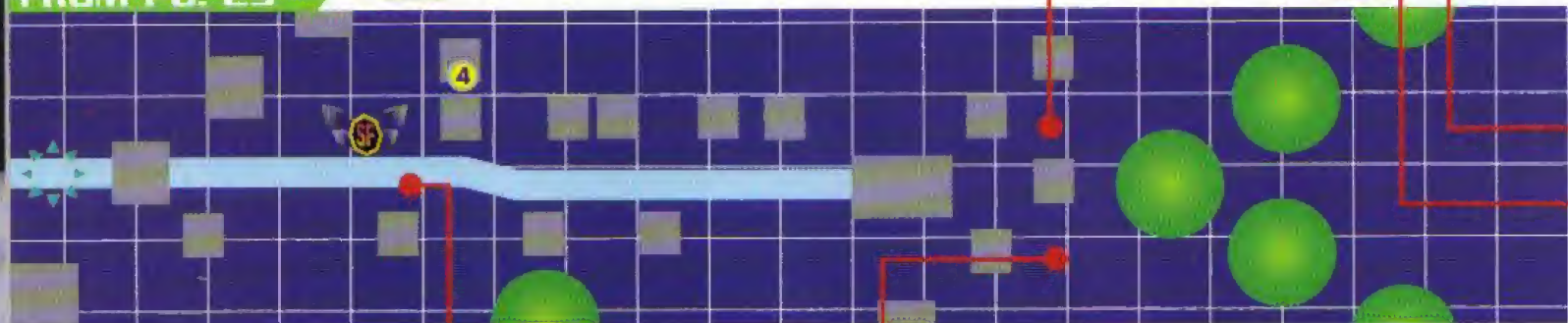

Ring, but don't ignore Falco's call for help, which occurs at about this time.

Destroy the three tanks on the road for a Supply Ring, but don't ignore Falco's call for help, which occurs at about this time.

If your Arwing has taken damage to the wing, the Laser Upgrade becomes a Wing Repair. There's also a Smart Bomb to the left.

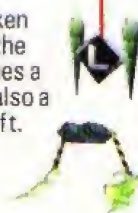

LOCK ON



BARRING NONE

Just beyond the bridge and four cannons are two Garudas carrying huge beams, which they will throw at you. Lock on the left bot first, then the bot on the right. If they throw the beams, just dodge upward.

4

TILTING AT TERROR



On the left side of the corridor are two buildings with a narrow passage between them. Tilt your Arwing on its side, fly through the middle and power up your laser. When you emerge, four enemy fighters will appear in front of you. Lock on to them and fire.

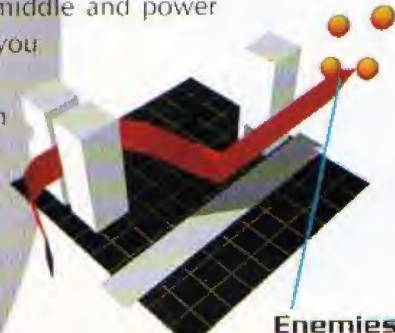

Enemies



DETOUR OF DUTY

PASSPORT TO Y

Open up the path to Sector Y by meeting two conditions. First, shoot down the three fighters trailing Falco after the Checkpoint. Next, fly beneath each of the seven stone arches in the lake. After the lake, follow Falco through a waterfall to Route 2.



ROUTE 1

ROUTE 2



If your Arwing has wing damage, a Wing Repair will appear here.



The Ski Bots move directly across your path between the arches. Knock them out as you skim the surface.



If you shoot down the Firebirds before they drop their bombs, you can pick up the Smart Bombs they leave behind.

02:00

02:15 TO PG. 32

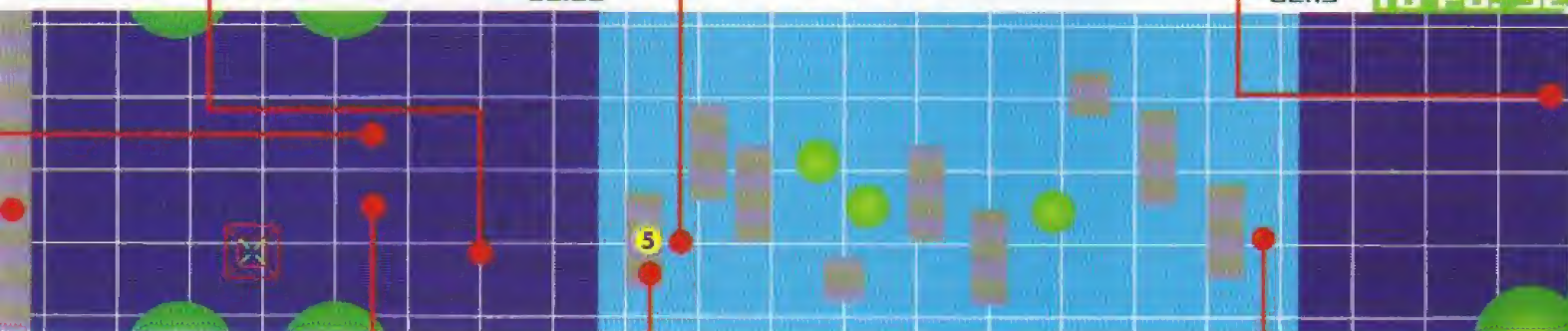

5 LOOP THE ARCH

Make a loop through the first arch after shooting the Ski Bot and pick up a Smart Bomb. Or you can simply shoot the Ski Bot before passing through the arch and pick up the bomb on the first pass through.

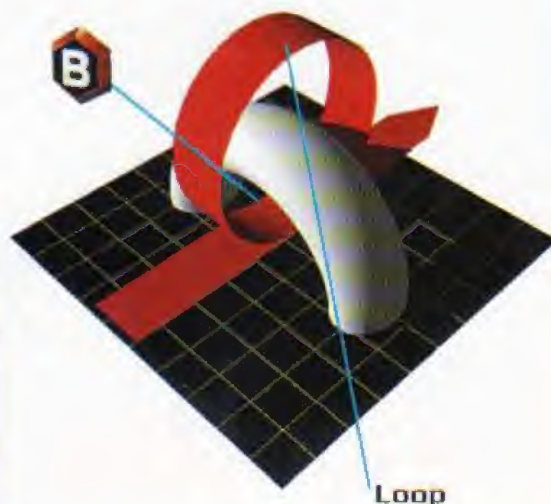

LYLAT DATALINK

CORNERIA ROCKS

The geology of Corneria may not seem like the most exciting topic in the Lylat System, but the porous, volcanic stone of Corneria has shaped the planet's history in many ways. Everywhere you go on the planet, you'll find that caves, tunnels, stone arches and crevices have been carved from the rock by the planet's many streams and rivers.

Throughout history, Cornerians have used these rocky refuges to hide from their oppressors. In times of war, the citizens flee to the hills and huddle far beneath the ground, safe until the fighting ends. Entire cities have been built in the larger cave systems to house the refugees. When the war ends and the people return home, they call it "rocking out."

ROUTE 1 FROM PG. 31 TO GRANGA

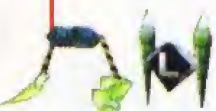
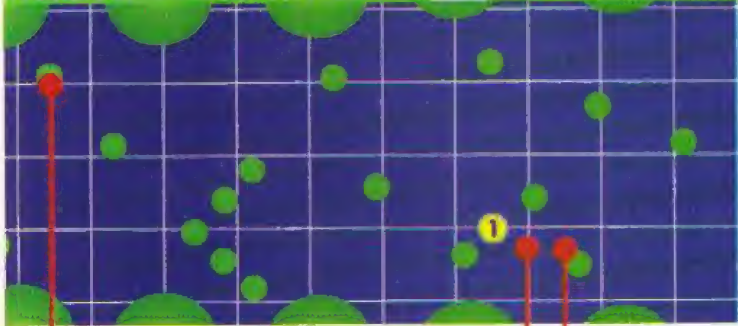

Depending on whether your ship is damaged, you'll find a Laser Upgrade or Wing Repair.

A Wing Repair appears after the waterfall on the left side of the valley amidst fierce Firebird bombing.



B Near the Shield Rings, shoot one of the Firebirds in the sky to make it become a Smart Bomb.

1

LOOP FOR GOLD



To get both Shield Rings, you must perform a special loop. Go through the upper ring first.

Then, as your Arwing is looping downward, push forward on the Control Stick to keep your nose down and reach the lower ring. Before making the approach, strafe the ground below the rings to destroy Mole Missiles.

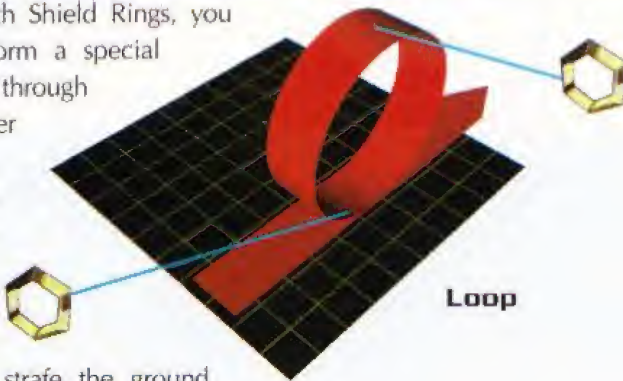

Loop

ROUTE 2 FROM PG. 31

02:45

03:00

TO CARRIER

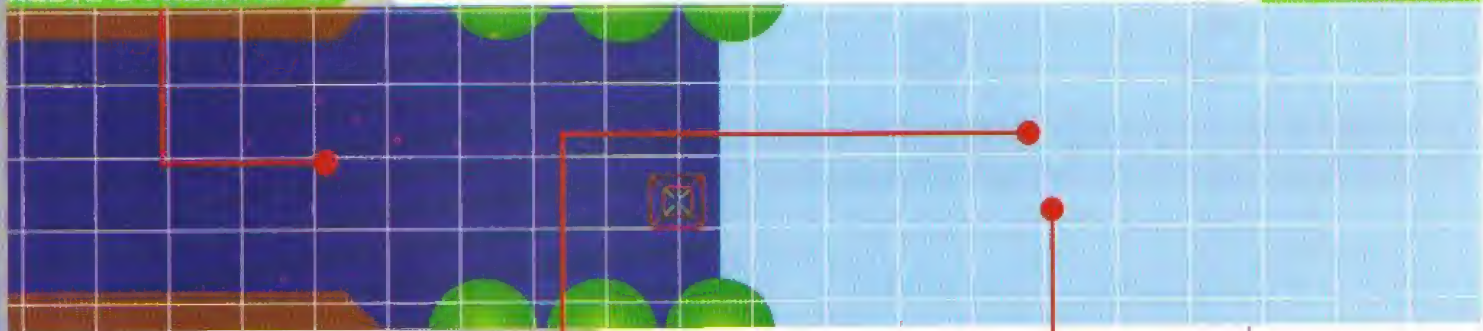

If you zap the three fighters on the left, a Laser Upgrade will appear.



Defeat the three fighters that appear on the right side of the course to earn a Supply Ring.



LOCK ON

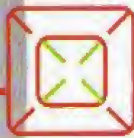

FORMATION TARGETS

Enemy groups, such as the two fighter squadrons in this valley, can be downed with a single shot. If you lock on one target, you can destroy the entire group. Use this technique everywhere for mass hits.



GRANGA **Route 1**

Granga is actually the little ape who drives the huge bot boss at the end of Route 1. He thinks that he's safe in the huge walker, but the bot is one of the most vulnerable targets in the game.

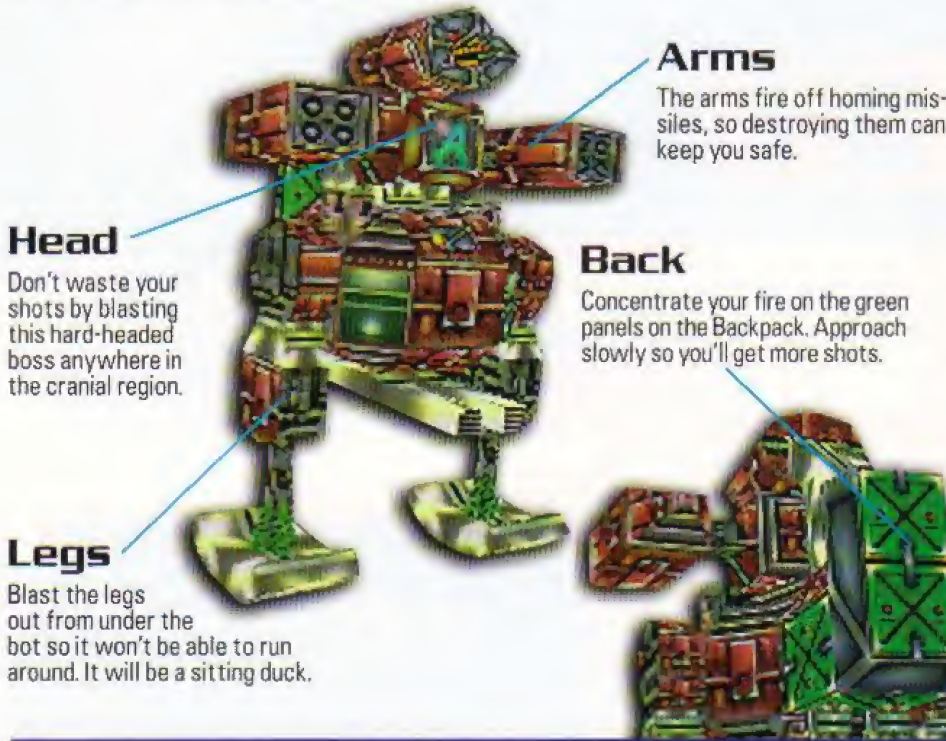
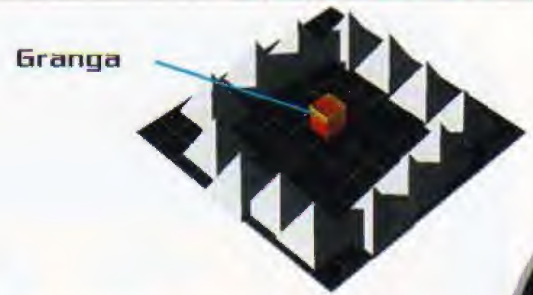

Head
Don't waste your shots by blasting this hard-headed boss anywhere in the cranial region.

Arms
The arms fire off homing missiles, so destroying them can keep you safe.

Back
Concentrate your fire on the green panels on the Backpack. Approach slowly so you'll get more shots.

Legs
Blast the legs out from under the bot so it won't be able to run around. It will be a sitting duck.



Cripple the bot with shots to the legs. Twin or hyper laser shots work very quickly.



If you fly between Granga's legs and complete a loop around the robot without touching anything, you'll find that a 1-up Arwing appears. This works only once.

TO METEO PG. 34

ATTACK CARRIER **Route 2**

Having followed Route 2 to the end, you, now encounter the Attack Carrier, a huge ship filled with enemy fighters. If you blast it out of the sky, you'll earn ten hit points.

When the launch bay doors are open, send volleys of laser fire into the exposed area. In addition to weakening the carrier, you'll destroy the missiles.

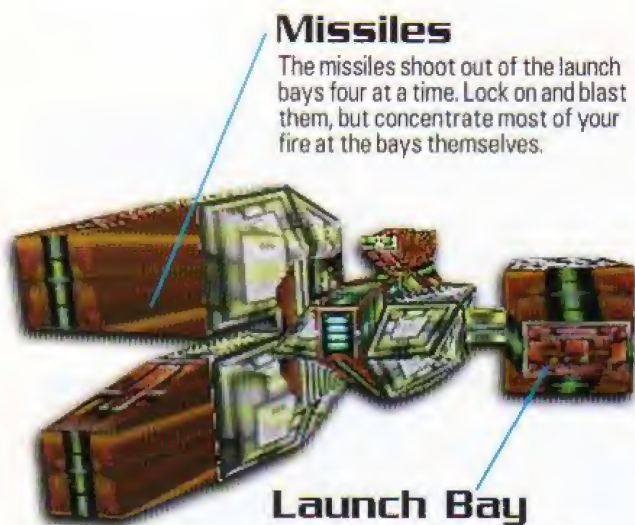

Missiles
The missiles shoot out of the launch bays four at a time. Lock on and blast them, but concentrate most of your fire at the bays themselves.

Launch Bay
Attack the open launch bays to destroy the offensive threat. When the carrier turns around, blast it and dodge the fire to finish it off.



If you blast the launch bays repeatedly when they are open, they'll fall off the carrier.



The carrier swings around and fires balls of flame at you. Just dodge and return fire.



TO SECTOR Y PG. 60

Mission 2

200 hits

METEO

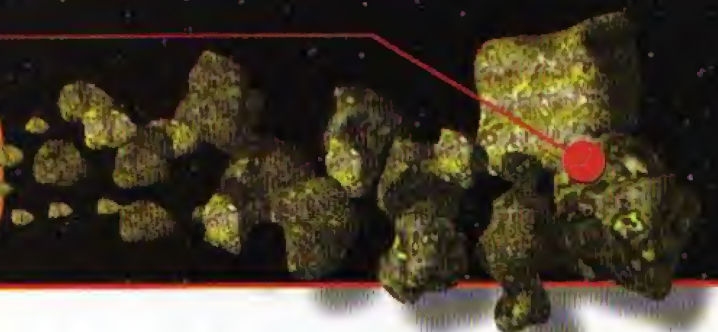

Our probes have picked up enemy activity in the Meteo planetoid system. It looks like Andross has built a planetoid crusher to clear a way through the belt for his invasion fleet. We need to have the Star Fox team check it out. Keep your eyes peeled as you move through the planetoids. Their movement is usually predictable, but if any of those rocks collide, it could send them careening off in wild directions. We've also scanned some unusual warp energy readings in the sector. If you find the source of to explore it to find out if it is part of Andross's attack.

1 TO FORTUNA CHALLENGE

➤➤

The icy former defense post of Fortuna presents another challenge from an army fleet. You'll take this route if you bypass the warps near the end of Meteo.

2 TO KATINA CHALLENGE

➤➤➤➤➤

The base at Katina is coming under fire from an enemy fleet. Fly through the seven warp rings to activate this route.



THE METEO MESS

This mission takes place in one of the most dangerous regions of space in the Lylat System. Giant asteroids litter the region between Corneria and Fortuna,

making the passage something of a deadly obstacle course. Keep your eyes peeled for rings of stones and other rings that you can pass through.



Astronomic Data

- Number of Objects.....1.32e6
- Average Albedo.....0.004
- Average Radius.....20 skm

Planetary Compendium

Scientists speculate that the dense planetoid field of Meteo is all that remains of a ninth planet in the Lylat system. The planetoids here contain many minerals, but the depth of the field has not yet been explored. Space travel in this sector is not recommended.

**ENEMY RECON****Hop Bot**

You'll find that this bot is hopping mad. It waits for you at the mouth of an asteroid with a tunnel bored through the middle, and it takes several shots to destroy it. As soon as you spot the Hop Bot in the distance, lock on and pop off a shot, then lock on again to finish it off.

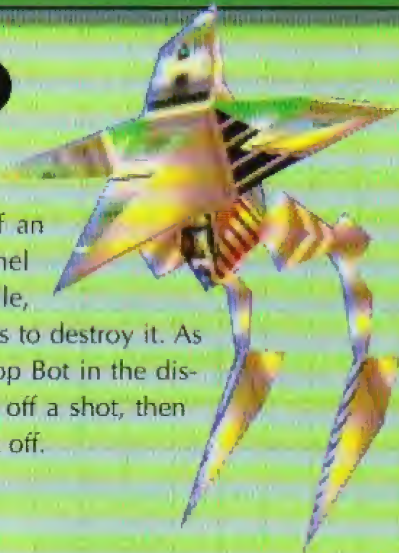
**Flip Bots**

Appearing in squadrons of four, the Flip Bots flip from front to back at different intervals, firing at you when they open up their back fins. When they face you, they're invulnerable. One shot into the open fins won't be enough.

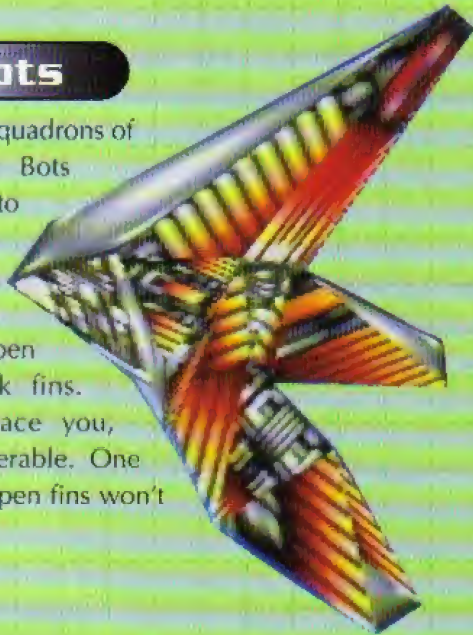
**Laser Cannons**

Laser cannons can be found in several stages. Here in the asteroid field, you'll encounter them inside the second big, hollow asteroid, just before you reach the web. Sometimes you can destroy an entire formation with one shot.

**Web Ships**

The Web Ships first appear spiraling around you. Avoid the long white web lines and blow away the ships. Then, as you leave the hollow asteroid, they build a web across the entrance. Blast the ships before they complete their webs.

**Moras**

These enemies undulate through space like eels in the ocean. They fire shots at you and can hit you with their bodies. Your best strategy is to get a laser



lock on their heads while dodging their shots. Persistence pays off.



Look for the Shield Ring to the left of the third ring of gray asteroids. Dodge the large asteroid in the third ring, then veer left to grab the gold ring.



LOCK ON

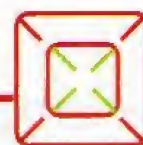

HIDDEN ENEMIES

You can lock on enemies even when you can't see them. In this area, a squadron of Butterfly Fighters waits to ambush you. Target the asteroids ahead, and when you get a lock, shoot the hidden enemies.



When you pass through the three rings of asteroids, a Laser Upgrade will appear between the small ring of four asteroids ahead.

START

00:15

00:30

00:45

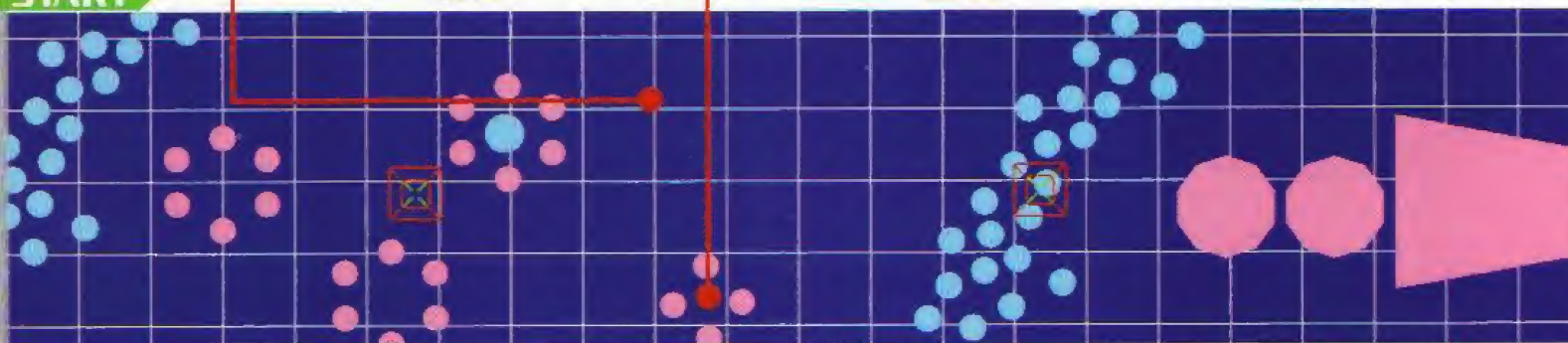

LOCK ON



NUKE THE ASTEROIDS

You can get multiple hit points by using Smart Bombs against the brown asteroids here at the first lock on icon. Lock on a target asteroid, then fire the bomb to get as many as 10 hits. Since this is an expensive way to use bombs, make sure you pick up all the bombs you can in the battle on Corneria in Mission 1.



1

GIFT LOOP



You can pick up three useful items with one maneuver after exiting the tunnel. The three items are stacked one above the other. Fly through the Shield Ring in the middle of this item stack, then immediately loop up to collect the Supply Ring. As you loop down and around, you'll also pick up the Smart Bomb. It's as easy as taking candy from an ape.



2 BRAKE OR BUST

The giant asteroids come crushing together at this point. A voice message warns that you should stomp on the brakes. Do it or your Arwing will be crushed like an egg between the asteroids.

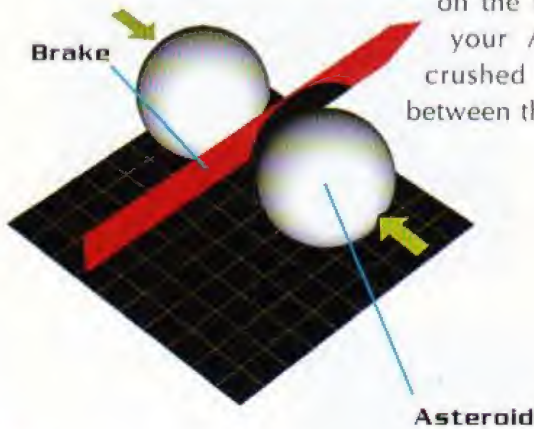

3 BOMB BOOST

When you hear the advice to boost between the gap in the asteroids, aim for the distant Smart Bomb icon and hit the booster to rocket ahead. You'll miss the asteroids and get the bomb, too.

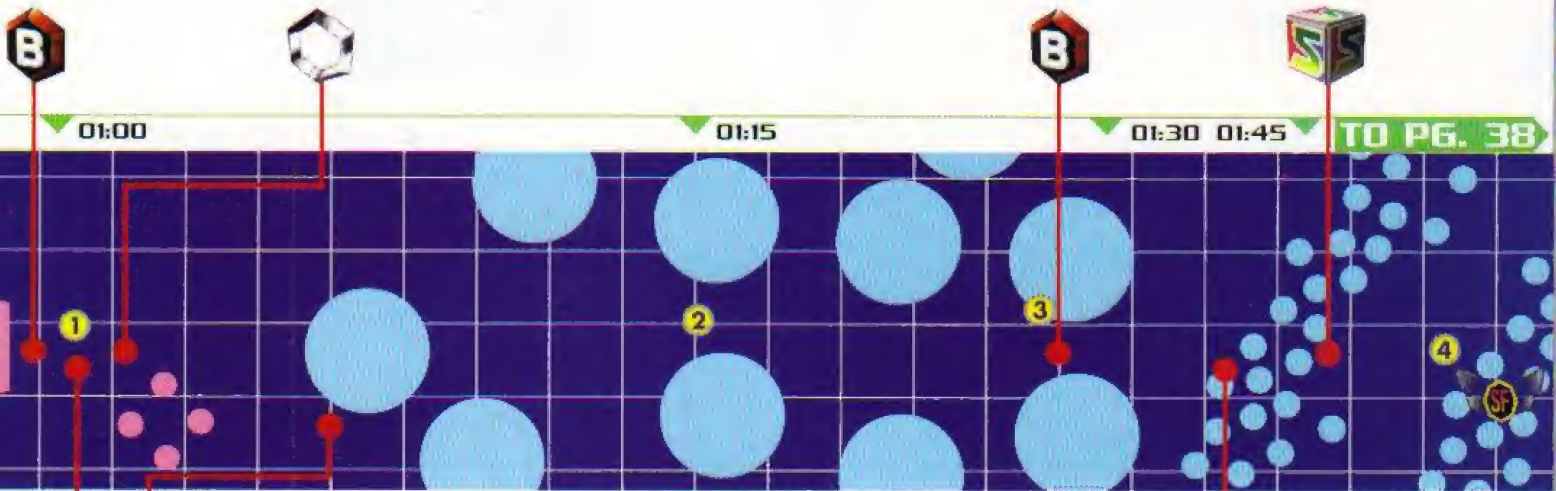
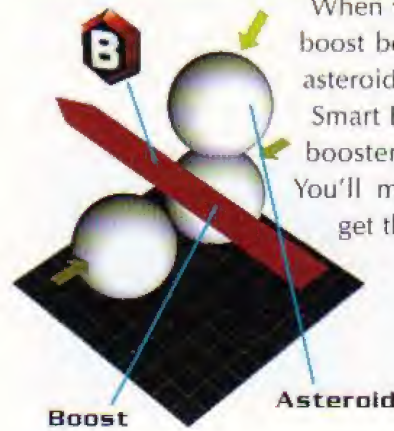

After the Gift Loop, swerve to the right and pass between the four asteroids. A Laser Upgrade will appear near the planetoid ahead.



Defeat the four Flip Bots to make a Smart Bomb appear. You can lock on Flip Bots only when they are facing backwards.



4 REARGUARD ACTION

Falco says to watch out when three Rock Gunner asteroids attack from the rear. Hit the brakes, let the Rock Gunners zip ahead, then lock on the middle enemy and roast them all with a single laser shot.



MAYDAY



A squadron of Venom Fighters is on Peppy's tail when he shoots past you. If you lock on your lasers, you'll probably miss one. Keep shooting until they're all finished.





LOCK ON

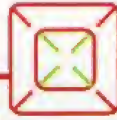

FORMATION FRYING

When you first reach the first Lock-on site shown, lock on the middle fighter in any formation to fry as many of the surrounding ships as possible with one shot. In some cases, you'll find items in the debris.



B If you defeat all five fighters, you can pick up a Smart Bomb.

L Blast all five fighters for a Laser Upgrade.



Weave back and forth to avoid the Killer Bee's laser. Zap it for a gold ring.

2 FALCO'S SUPPORT

If Falco is with you when you exit the tunnel, he'll help you battle the Web Ships and the fighters that follow. Wave after wave of formation fighters attack following the grid. Lock on to the middle fighter to wipe out entire formations.



FROM PG. 37

02:00

02:15

02:30

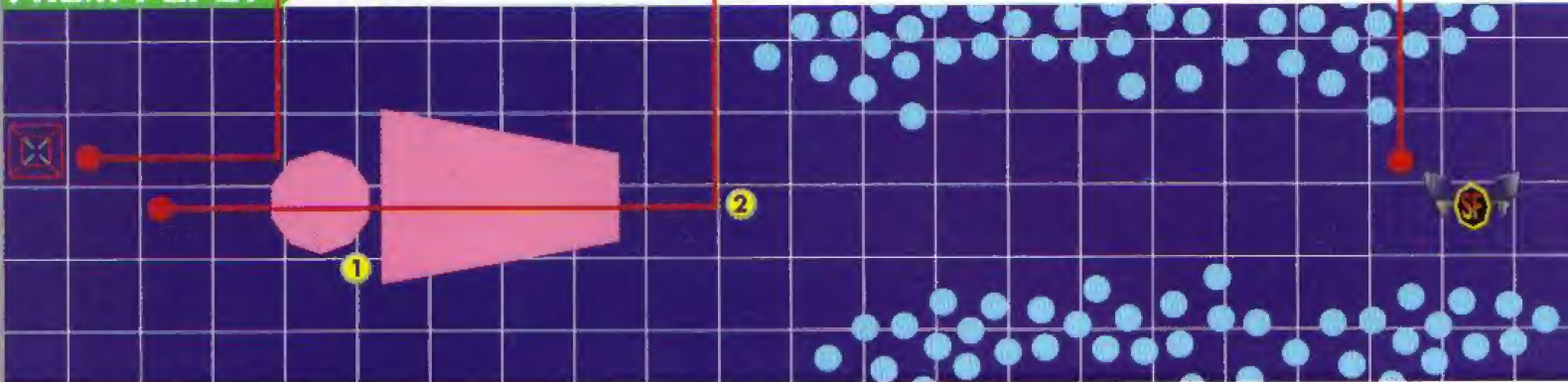

1

CAGED FOX



The Web Ships build a strong cage in which to catch you, but there's a gap on the far right side, about halfway up the web, where you can squeeze through and escape. On the way into the tunnel, stay in the middle of the spiral web to avoid being hit. Lock on to the Web ships and blast them.

Rolling

Battery

MAYDAY



Slippy's in trouble again when a squadron of Flip Bot fighters chases him toward the Checkpoint. You'll need to hit the fighters several times to destroy them.



LOCK ON
SEVENTH HEAVEN

The Butterfly Fighters blossom from tight formations of seven ships to wide, spinning circles. Lock on when they're still close together and you'll take out the entire formation worth seven hit points. If you're shooting for the warp, though, just ignore these fighters and concentrate on staying in the correct flight path.



Blast this asteroid apart to find the Shield Ring inside.

DETOUR OF DUTY
THE WARP RINGS

Fly through all seven warp rings to move on to Katina instead of Fortuna. Each warp ring increases your speed, and the Rumble Pak will really jump. If you make it, you'll warp into an area with odd fish and butterfly enemies and a treasure trove of items.

TO KATINA PG. 66

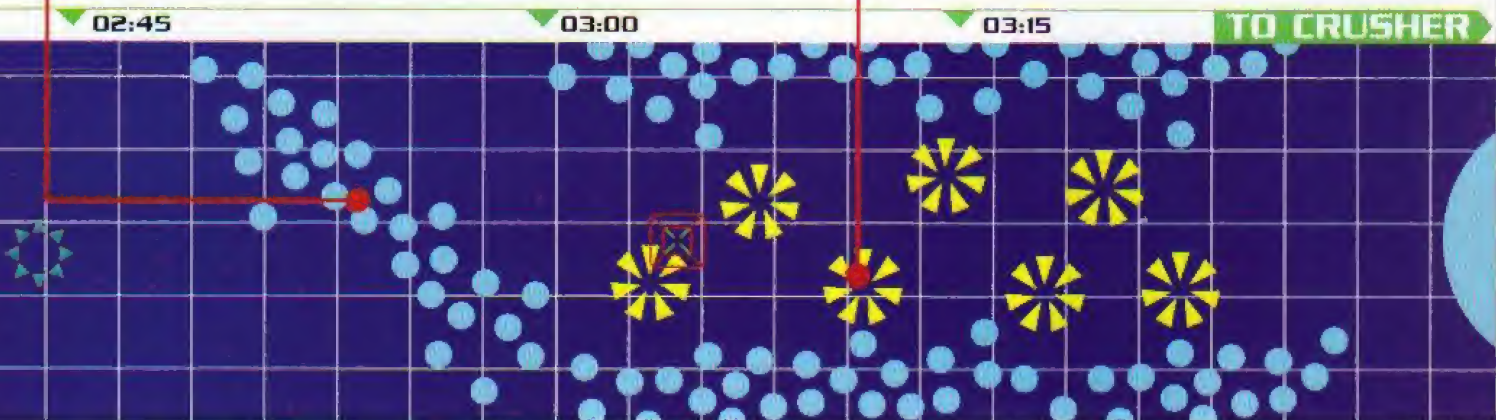

METEO CRUSHER

Shield

The shield on the back side of the Crusher absorbs energy from your laser and shoots it back. It's easy to dodge if you watch for it.

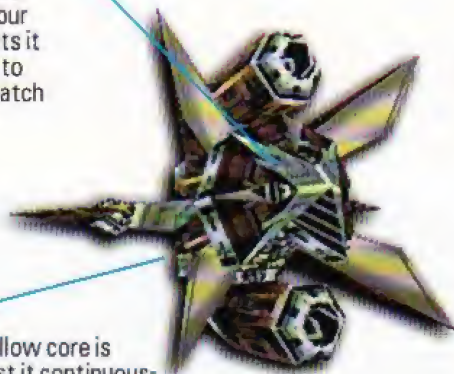

Core

When the yellow core is exposed, blast it continuously. Only the core can take damage and destroy the Crusher.

The Crusher cleans up messy areas of space where unwanted asteroids and planets block the space lanes. It wouldn't seem like cleaning up four Arwings should be much of a problem. It's your job to see that it is.



Destroy all four core segments to make the Crusher turn an about-face.



Avoid the ring laser by dodging upward or to the side. Move early to escape this attack.

TO FORTUNA PG. 40

Mission 3

FORTUNA

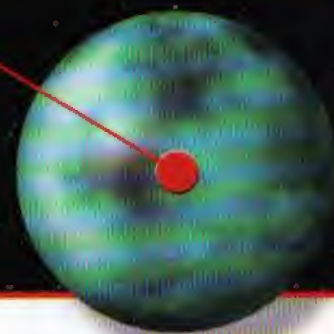

Our base on Fortuna has been overrun by Andross's forces! We need to liberate it from their clutches before he has a chance to use the top secret information stored there for his own evil ends! Go to Fortuna and scout out the base, but be on the lookout for enemy fighters. Your old rivals, the Star Wolf team of space pirates, are also rumored to be in the area, so watch your six! I know what Pigma Dengar did to your father, Fox, but don't let your emotions get the best of you!

1

TO SECTOR X
CHALLENGE

If Star Wolf and his cohorts manage to destroy the Fortuna base, General Pepper will then order you to Sector X to take up the battle there.

2

TO SOLAR
CHALLENGE

If you are successful in recapturing the Fortuna base from Andross's clutches, you'll then proceed to Solar.



FORTUNES OF WAR

Satellite transmissions show that the skies above the Fortuna base are clear, but expect an ambush from enemy craft. Keep an eye on your radar and use charged-up lasers to take out groups of two and three at a time. Long-range sensors indicate that the Star Wolf team is en route and will be here within just a few

minutes, so clear out any enemy resistance as quickly as possible. Star Wolf's ships can repel charged-up lasers, but they are vulnerable to normal laser fire. Laser Upgrades are few and far between on Fortuna, but you should have no trouble finding Supply Rings and Shield Rings.



Planetary Data

- Radius.....3,277 skm
- Albedo.....0.55
- Gravity.....0.367
- Esc. Velocity.....4.99 skm/s
- Equilibrium K.....220
- Atmosphere.....N267+O223
- Hydrographics....53%
- Biomass.....270 Quads
- Class.....I

Planetary Compendium

Fortuna, an icy world devoid of vegetation, is home to only a few members of the Comerian Defense Force and a team of scientists. Because of the large amount of frozen water on the planet, it is an ideal candidate for terra forming, and there is some thought that it might be possible to convert it into a garden world, much like Comeria.



ENEMY RECON

Wolfen

The Wolfen is fast, highly maneuverable and, with two laser cannons as standard equipment, very well-armed. Its shields are not as powerful as the Arwing's shields, but in the hands of a pilot like Star Wolf, this craft is a force to be reckoned with.

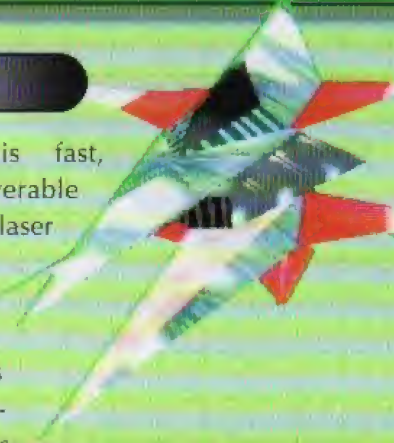

Invader I

A common strategy for Invader flight groups is to use two or more lead ships to draw your fire. Once your attention is focused on the lead ships, another craft will drop in and try to ambush you from behind.



Fortuna Base

This is the main Fortuna base complex. It is heavily shielded, so you don't have to worry about damaging it with your lasers or even your bombs. Andross's forces have barricaded themselves inside, but you can bet that the unwelcome wagon will come out to greet you as soon as you show up on the doorstep.

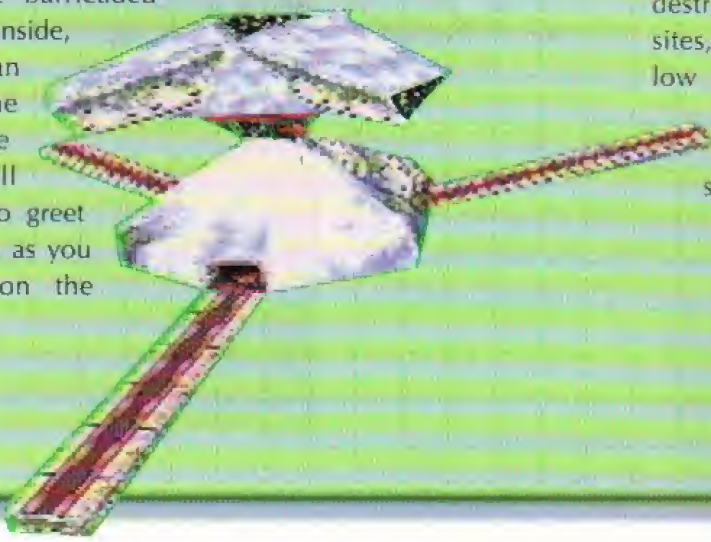

Radar Sites

The Fortuna base is ringed by a network of radar antennas. These are used as part of an early warning system by the military, as well as for local space traffic control. You don't receive any hit points for destroying these sites, so if you're low on points for the mission, you probably shouldn't waste time on them.



SHIELDS UP!

Keep your eyes and ears open for Shield Rings. If destroying an Invader produces a Shield Ring, you'll hear a chime. If you pass a ring without picking it up, it may disappear before you turn around.



If you're looking for items, hang back from your targets as you destroy them or you may miss a Shield Ring.



After you shoot down three members of the Star Wolf team, ROB 64 will contact you to see if you need a resupply.

SECRET SUPPLIES

The radar sites hold hidden bonuses. Though you don't get any hit points for destroying them (they are Cornerian military property, after all), they do contain Supply Rings. The map above shows the exact location of each site around the perimeter of the complex. Some of them are out of the way, and getting to them may eat up precious time that could be used for taking out enemy ships. If your shields are buckling, though, you may have little choice.



STAR WOLF

Star Wolf and his cohorts are all crack pilots, so don't underestimate them. If you tag them from behind, they'll pull a loop or a U-turn to get out of the line of fire. Be ready to match their moves.

Tough to Crack

The Wolfen can shrug off charged-up lasers without getting a scratch and withstand multiple hits from even your hyper lasers.

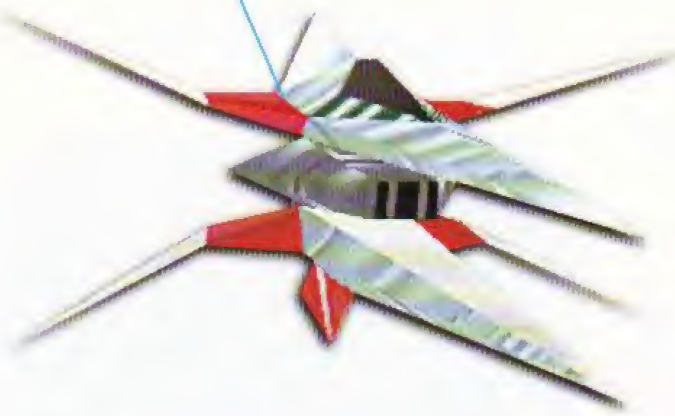

The Star Wolf team's ships are displayed as black icons on the radar. When you see one of them close in, be ready to take evasive action.



Pulling a quick loop may catch even Star Wolf by surprise. The enemy may also take evasive action, so be ready on the stick.

Now drop in behind your target and squeeze off a few well-aimed shots. Bank hard or barrel roll to keep the target in your sights.

DETOUR OF DUTY

DEFUSE THE BOMB

Your only hope for saving the base is to shoot down all enemy craft and defuse the bomb before it explodes. Once the chain reaction begins, you'll have only a minute before it goes critical. If you're having trouble following targets, switch to the wide-angle view.



MISSION ACCOMPLISHED

All four members of the Star Wolf team have been shot down and the bomb disarmed. Reinforcements are on their way to Fortuna, but you and your team must take off immediately to investigate reports of an enemy bioweapon on the planet Solar. Good luck!

MISSION CRITICAL

The Fortuna base is destroyed, but the fleet is going to regroup and press on. In the confusion, your team should be able to slip past Andross's patrols. Your orders are to proceed on toward Venom via Sector X. Be ready to meet heavy resistance from an enemy bioweapon!



TO SOLAR PG. 70



TO SECTOR X PG. 44

Mission 4

150 hits

SECTOR X



Our spies report that Andross has been developing a star base in Sector X, but all that our remote sensors can now pick up is a huge field of space debris. We can't tell if Andross's base construction project has been destroyed by some kind of accident, or if this is part of his plan. It could also be a trap. Our scientists have also detected unusual "worm hole" radiation in the sector. In case a worm hole warp is part of Andross's invasion plans, we need to have you explore where the warp might lead!

1 TO TITANIA CHALLENGE

Andross has given orders that the team be destroyed or captured. If captured, you're to be taken to Titania.

2 TO MACBETH CHALLENGE: >>>>

If you make it through Sector X without losing any wingmen, move on to Andross's supply depot on Macbeth and take it out!

3 TO SECTOR Z CHALLENGE

Rumor has it that there's a long-forgotten warp gate connecting this sector with Sector Z, clear across the system. Try to find the remnants of the gate among the debris.

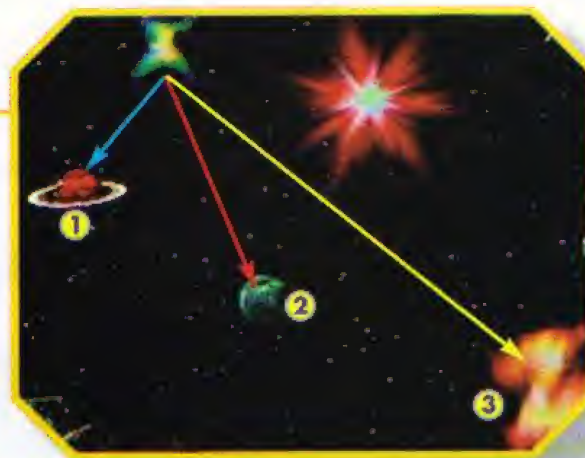

X MARKS THE SPOT

Andross's base has been blasted into space junk. Of course, they've turned the chaos to their advantage by hiding huge fighter squadrons and gun emplacements among the debris. With so many targets, you might not have trouble racking up the 150 hits needed for a medal, even without Smart Bombs.

When large squadrons appear, lock on and fire a charged-up laser at one side of the screen and then immediately spray the other side with normal lasers. If you're going for a high score, take the right-hand path, which has far more enemies than the left-hand path. The left-hand path leads to the secret warp.



Sector Data

- Radiation.....7.27 érgons
- Mag Flux.....64%
- Particle Density....59 c/sg
- Average Albedo....0.73
- Approx. Radius.....19,871 skm

Astronomic Data

Sector X is one of three mysterious zones where luminous space dust has formed a nebula that appears in the shape of a giant letter. Scientist are sure these formations aren't natural, but so far no one has explained the phenomena. Sector X has many strange magnetic currents that make travel extremely hazardous.

**ENEMY RECON****Canines**

Andross has dropped hundreds of these nasty robotic fighters in this sector. A hunter program activates them automatically when it detects hostile ships—namely, yours. They're not very powerful individually, but they can be very destructive in large numbers.

**Spy Eyes**

Spy Eyes do not possess any offensive weapons, and it is believed that they are some sort of early warning satellite. Some may also function as a kind of supply depot, since they often contain Supply Rings and other items. Look carefully, as many of them are hidden among the floating space debris.

**SX Space Mines**

These deceptively small mines produce incredibly large explosions when you get close to them. Lock on to them while they're still far away. If you're lucky, a charged-up bolt will take out two or three.

**SX Lasers**

These powerful, unmanned lasers have been placed in groups of two, four and six throughout the second half of the stage. Their targeting sensors work fairly well, and they're often backed up by two or more squadrons of Canines.

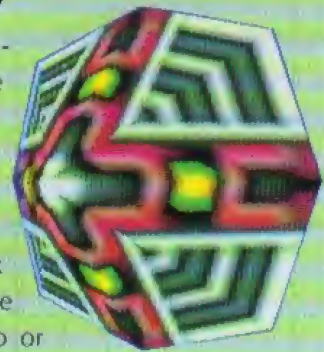
**Killer Bees**

As you probably know by now, it's impossible to get a lock on Killer Bees, so try to stay near the center of the screen and make small adjustments as you shoot. Besides racking up four hits, you may also receive a Shield Ring for your trouble.

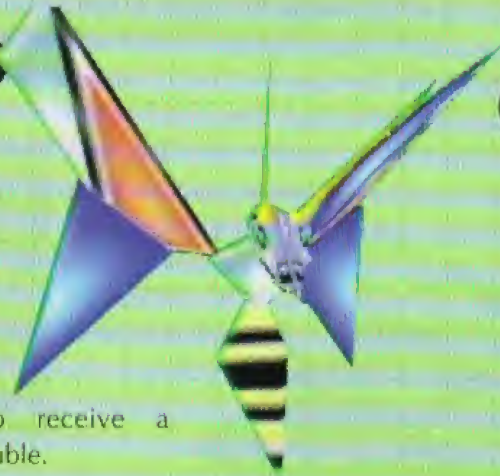
**Borzoi Fighters**

Whereas Canines tend to form a single line and fly straight at you, these next-generation robot fighters have a much more sophisticated attack program. Alone or in a group, Borzoi Fighters flit around at high speed, pausing for only a second to fire before it speeds off again.

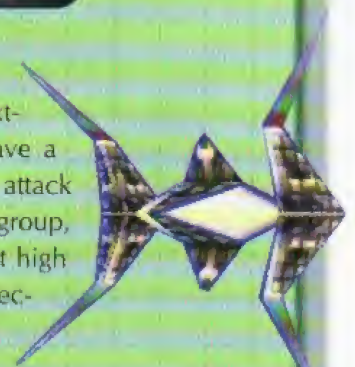



In the second large wave of fighters to appear, destroy the last trio that comes in from the left for a Shield Ring.

They're hard to spot in the crowd, but lock on to the four Vipers that swoop in from the lower left for an upgrade.



1 TRY TWO TACTICS

There are two ways to approach the minefield. You can either take it low and slow and try to destroy the mines, or you can hit the booster and try to outrun the shockwaves from the explosions.

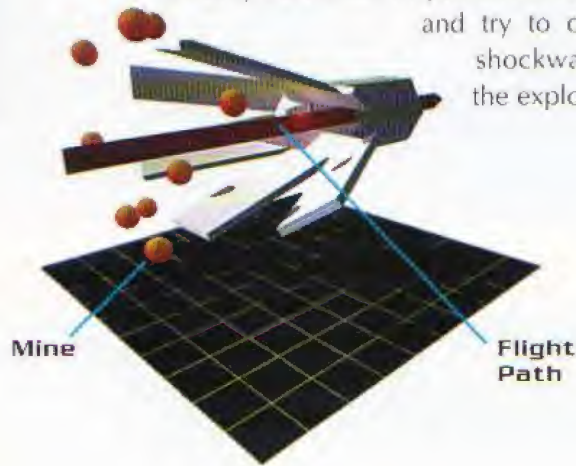

Stay alert for the sudden appearance of a Killer Bee. Defeat it for a Shield Ring.



START

00:15

00:30

00:45

01:00

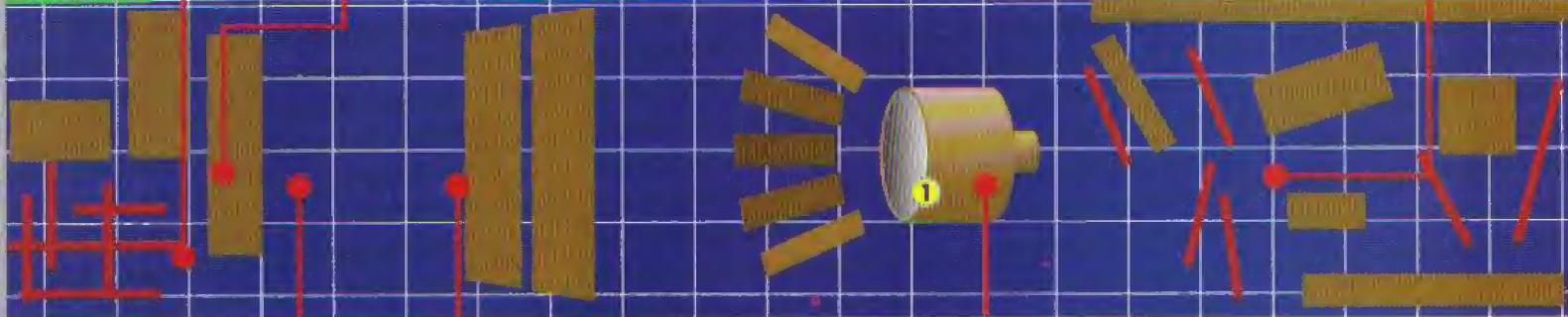

A trio of Borzoi fighters will swoop in, one after the other. Your chances of bagging Supply Rings is better if your Shield Gauge is low.



Three flights of Borzoi fighters will link up at these coordinates. Lock on with a Smart Bomb and take them out all at once for a Shield Ring.



Fry the three Spy Eyes that are located just beyond the mines for a Laser Upgrade.

2 HEAVY METAL

Fly through the Checkpoint for a full shield recharge. There's a wall dead ahead, but it will burst open as you approach, and a huge metal fist will come right at you.

Your weapons won't even dent it, so dodge up and to the left.

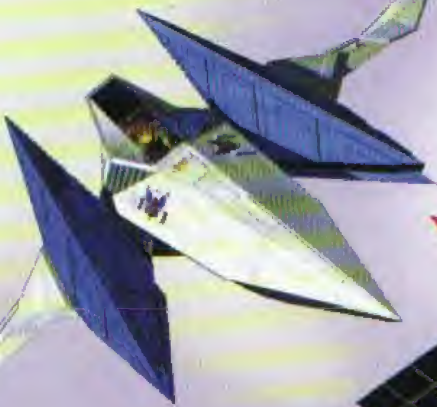
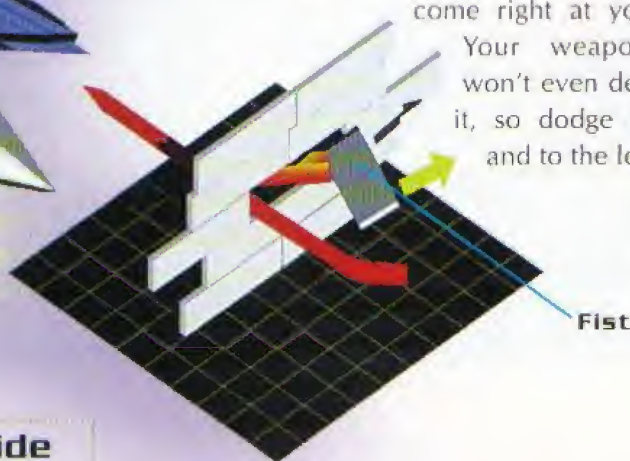

3 POINT OF NO RETURN

This is where the path through the sector splits in two. If you want to find out if the mechanism to the warp gate still works, head left. If you want to take your chances with the rest of Andross's fleet, head right. If you don't activate the warp gate, you'll remain in this sector and face the awesome Spyborg!



Left



Right

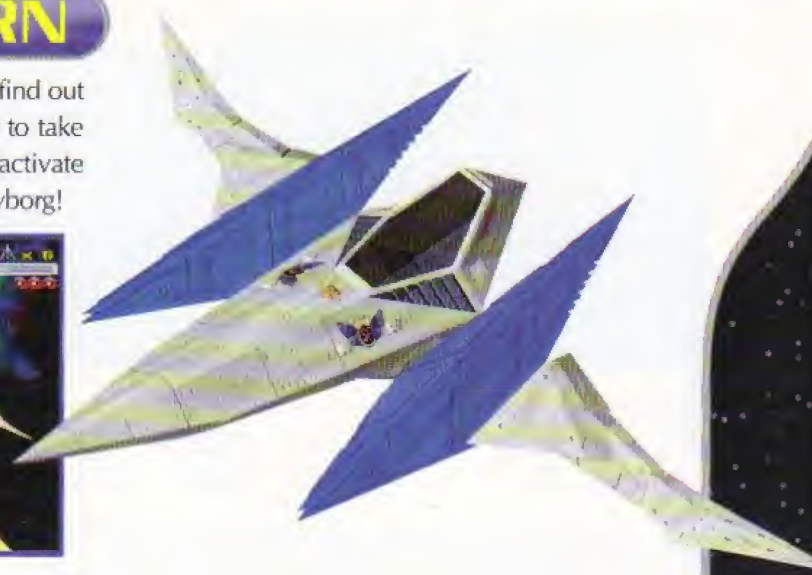

Sensors indicate that the Spy Eye at these coordinates has a Shield Ring in its cargo hold. Take it out!

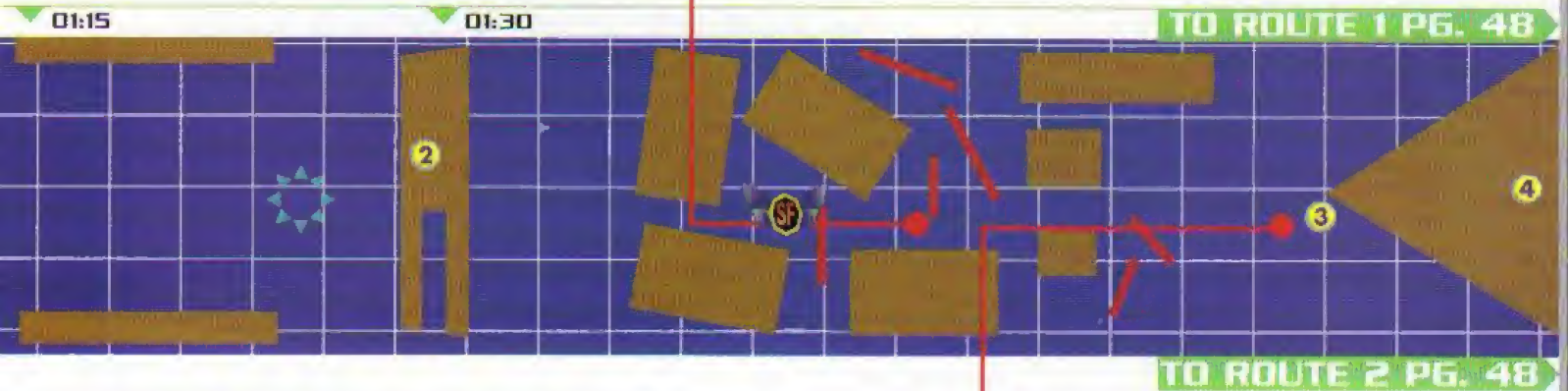

Avoid another flying fist and destroy the Spy Eyes for a Laser Upgrade.

MAYDAY

Peppy's in trouble, and it wouldn't do to let your Papa's old pal get pasted by a bunch of lousy robot fighters. Use the booster to bring your Arwing to within lock-on range. If you don't pick off his pursuers in time, Peppy will have to limp back to the Great Fox docking bay for repairs.

4 HIDDEN PATHS

Just beyond the fork in the path, there are two secret passages through the debris. If you're on the left, you can grab a Laser Upgrade. If you're on the right, you can collect a Supply Ring.

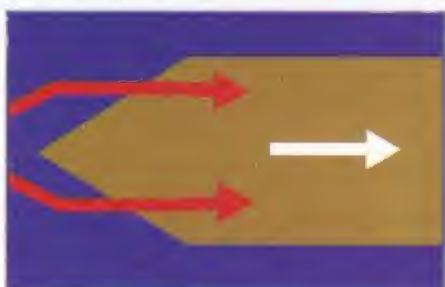

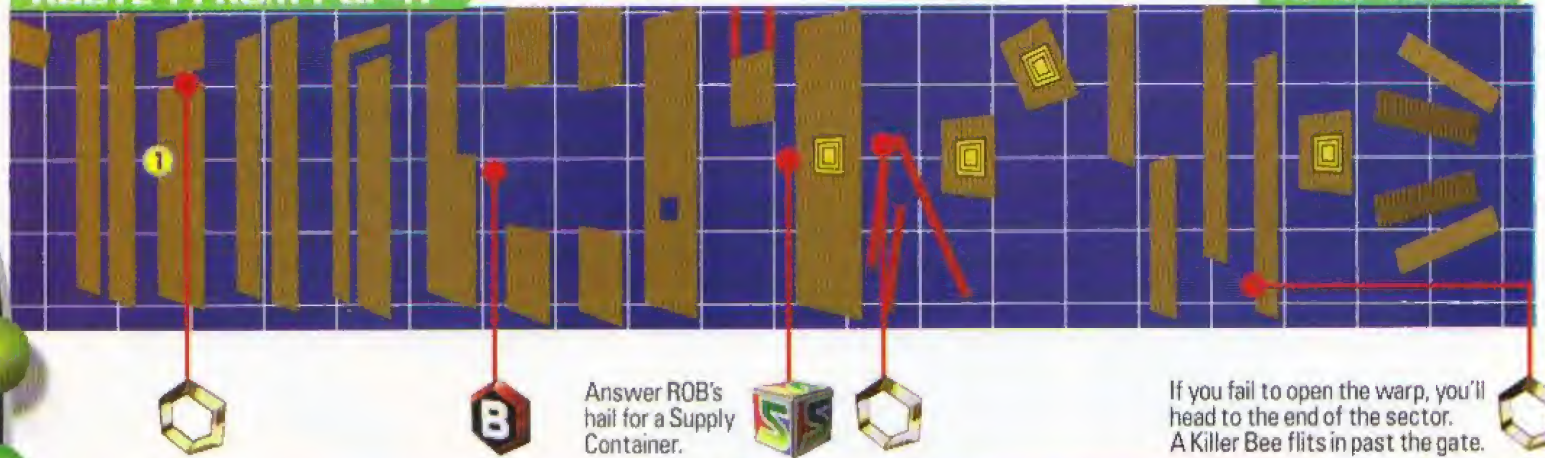

1 CLOSE SESAME

Though the path looks wide open, it's actually been strewn with booby traps. The walls have been rigged to slide together, leaving you small spaces just wide enough for the Arwing to pass through. Tilt, boost and brake as needed to avoid smashing into obstacles.



An entire squadron of Canines will get in your face here. Blast them for a ring.



DETOUR OF DUTY

OPEN SESAME

Shoot each of the four warp gates until it turns red and opens. If successful, you'll activate the warp and be transported to Sector Z. Only those Arwing pilots with dead-eye aim and a quick trigger finger need apply!



TO SECTOR Z PG. 96

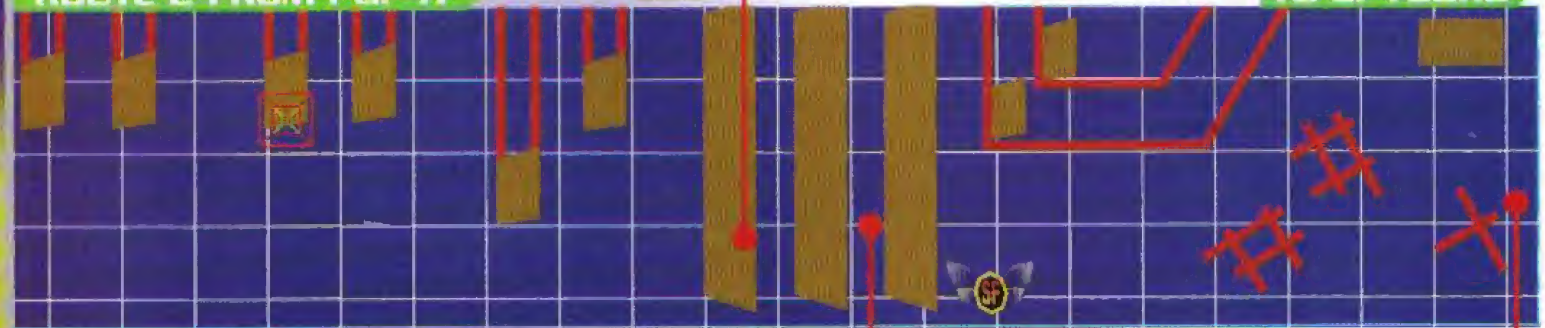

LOCK ON

FIRE AT WILL

This path is thick with enemy ships of all types. Always use charged lasers to destroy groups of ships and then use normal laser blasts to clean up the strays. If you've fired a charged-up laser using the target lock, you won't be able to lock on again until after the first one has detonated.



Another Killer Bee will pop in from the right. Pop him for a Shield Ring.



MAYDAY



Help Peppy with a charged-up laser or two, but be careful of the string of Canines chasing him. As they chase him, the last fighters in the string might whip around and collide with you.



SPYBORG

This mechanical monstrosity is the result of a weapons project gone awry. Andross had hoped to use it against Corneria, but a malfunction in its artificial intelligence program has made it uncontrollable. It destroyed Andross's research base here in Sector X, and now it's gunning for you. It seems obsessed with finding its creator, but maybe you can give it something else to worry about!

Head

In the first phase, shoot at the head only when the eyes are showing. The entire head is

vulnerable in the second phase, but it's also smaller and harder to hit.



During the first phase, Spyborg alternates between laser attacks from its head and arm attacks. The arms are invulnerable, so don't bother shooting them.

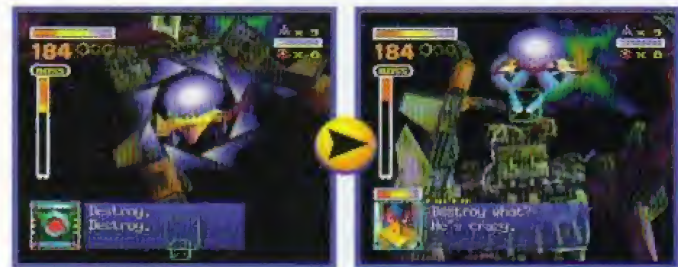

In the second phase, the laser attacks become harder to dodge, and Spyborg will start flailing its arms. Keep shooting at its head to bring it down.

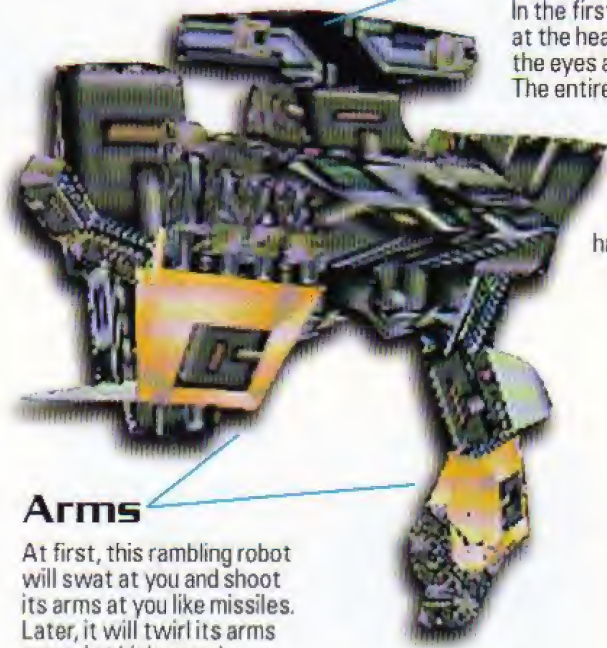

Arms

At first, this rambling robot will swat at you and shoot its arms at you like missiles. Later, it will twirl its arms around at high speed.

DETOUR OF DUTY

SAVE SLIPPY

If you take too long to destroy Spyborg, Slippy will jump into the battle to help you out. Spyborg will then knock Slippy off course and send him tumbling toward the planet Titania, where he'll be taken prisoner. If that happens, you'll have to take a detour to rescue him.

DISASTER AVERTED

Alternating between rapid-fire laser blasts and charged-up lasers or bombs was the only way to ensure that Spyborg was destroyed before anyone was hurt. Now that Sector X is clear, your orders are to proceed to Macbeth. It's time to take the offensive and strike back at Andross right where it hurts—his supply lines!

SEARCH AND RESCUE

Slippy is down, and he's not answering any of our hails. ROB has charted a course based on his last known trajectory, and it leads straight toward Titania. Andross's fleet controls the skies over that world, so it's time to take the Landmaster out for a little spin around the neighborhood!



TO MACBETH PG. 76

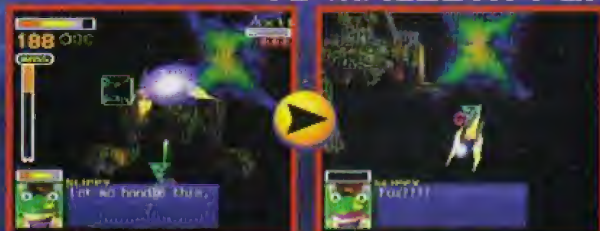

TO TITANIA PG. 50

Mission 5

150 hits

TITANIA

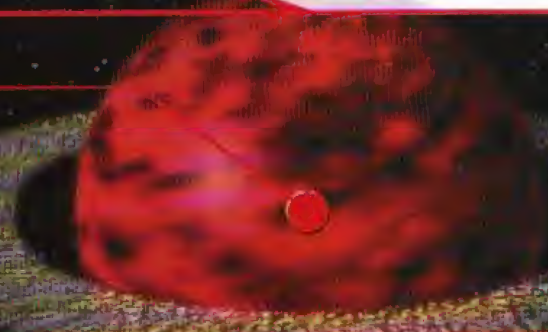

TO BOLSE CHALLENGE



If you blast past the onslaught of desert enemies and obstacles and rescue Slippy Toad by destroying his captor, your mission will resume, and the entire Star Fox team can head for Bolse.



Traffic to Titania is usually restricted,

but we have heard that Andross's scout forces are on the planet. We don't know what they're up to, but if they can gain control of the technology of the planet's ancient Goras defense system, who knows what Andross might use it for. Get down there and see what Andross is planning, and neutralize Goras if you can! Since Corneria's tank corps is limited, your team's Landmaster is the only vehicle that can do the job. Good luck!



ROAMING THE TITANIAN DESERT

Slippy couldn't have crash landed in a worse place. Titania is a sandy dust bowl of rolling dunes devoid of vegetation, save for a few uninviting throngs of cacti. The planet may be an arid desert, but it's more like a catch basin drenched with oceans of dangers and overwhelming waves of titanic

enemies. If the floods of land mines and toppling columns don't stop your Landmaster in its tracks, the assault vehicles probably will. The wasteland teems with enemies in the air and on the ground, so be ready to turn on a dime and hover in a split second because they'll assault you from all sides.



Planetary Data

- Radius.....4,397 km
- Albedo.....0.15
- Gravity.....0.48
- Esc Velocity.....6.79 km/s
- Equilibrium K.....226
- Atmosphere.....N230.0223.00223
- Hydrographics.....0%
- Biomass.....355 Quads
- Class.....D

Planetary Compendium

Titania is known as the "Red Planet" because of the huge ion storms that swirl dust from the surface of the planet into its stratosphere. Archaeologists have found surprisingly advanced ancient ruins on this planet, and, in fact, a high-tech, planetary defense system, code named, "Goras," is still active.



ENEMY RECON

Land Mines

Volatile land mines pave the road leading to Slippy Toad. The mines are sensitive and your tank can detonate them with the slightest pressure, so don't tread on them. Avoid the explosives either by hitting Z and R to hover over them or by locking on to them and firing to blast them out of your path.



Bombers

Keep your sights fixed on these bird-like ships and be ready to swerve or hover, because they'll swoop across your path to dump land mines in front of you.



Desert Crawlers

Titania is plagued by lumbering Desert Crawlers. They look formidable, but since they're massive, slow and unable to fire, they're easy targets. As long you avoid coming into contact with them, you'll be able to destroy them by exploiting their weak spots: their underbellies.



Desert Rovers

Roving tankbots patrol the deserts of Titania, steadfastly rolling along launching laser missiles from their cannons. Unlike your Landmaster, however, these tanks aren't very maneuverable, so they tend to move along on a fairly fixed and predictable path. It takes only a single blast to obliterate one.



Rascos

The Rascos will make sure your drive through Titania is a bumpy one. The smooth desert floor becomes a rocky road as these robots hurl an avalanche of boulders at you. Blast them to stop their pitching and earn one hit point.

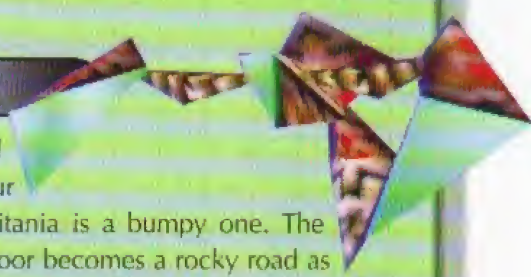

Cacti

Spiny cacti dot Titania's sweltering sandscape, but they pose no threat to your armored Landmaster. If you shoot or plow over them, you can reap the fruits of your harvest by claiming the bonus rings that sometimes sprout in their place.

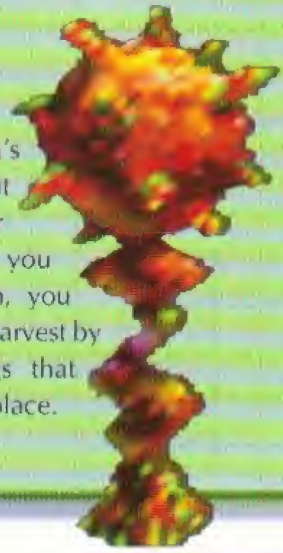

1 FALLING COLUMN FAKE-OUT



Unstable columns topple over to block your path by falling left if you approach from the left, or falling right if you approach from the right. To reach an item sitting beside a column, fool the pillar into falling away from the item by faking it out. Drive toward where you want the column to tumble over. When it falls for your trick and tips over, swerve to the opposite side to claim your bonus item.

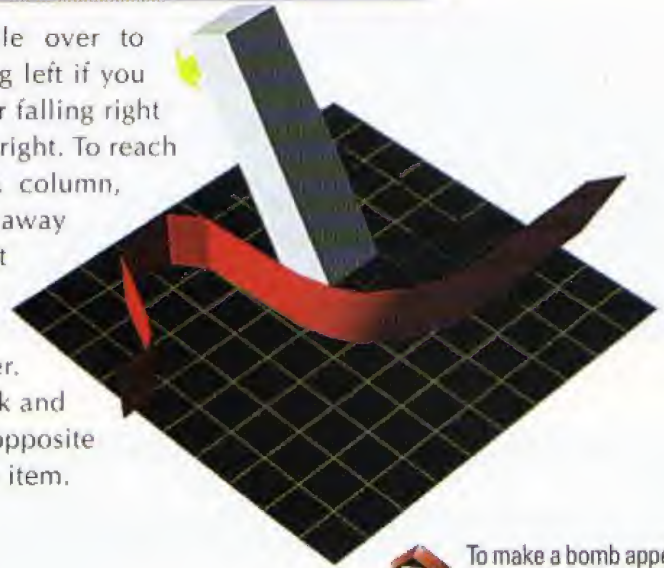

To make a bomb appear, plow through the tunnel of arches in the middle and the next tunnel on the left.



LOCK ON



UNDERMINING MINES

It's no Sunday drive rolling through Titania. Land mines can blow you off course violently if you drive over them, so shoot them out of your way. However, the Landmaster's cannon has trouble aiming low enough to blow them away, so lock on to them first, then fire. Your homing lasers will zero in on the land mines to clear a safe passage.



2 BELLY BLAST



To earn four hit points, fire away at the Crawler's underside. Attack it by driving between its legs and firing up at its stomach—as long as you don't come into contact with any part of its body, you'll be safe. It takes a while before it shows signs of defeat, but once you see Hit+3 appear, you can cease fire and watch the robot harmlessly collapse.

It takes a while before it shows signs of defeat, but once you see Hit+3 appear, you can cease fire and watch the robot harmlessly collapse.



THE RED PLANET

Millions of years ago, Titania was a thriving planet populated by an advanced agrarian civilization. Interspersed between the farming communities were ornate cities of stone that the Titanians constructed using advanced engineering and architectural techniques. The centerpiece of every town was its temple, where villagers would leave their harvests to appease the fearsome Goras. Now, two million years after an asteroid collided with Titania, the Goras is the only surviving creature roaming the planet. A far cry from the lush, green planet it once was, Titania has become a barren wasteland of deserts and dunes. Even the Goras is different—a direct result of Andross's biomechanical experimentation.



01:30

01:45

02:00

TO PG. 54

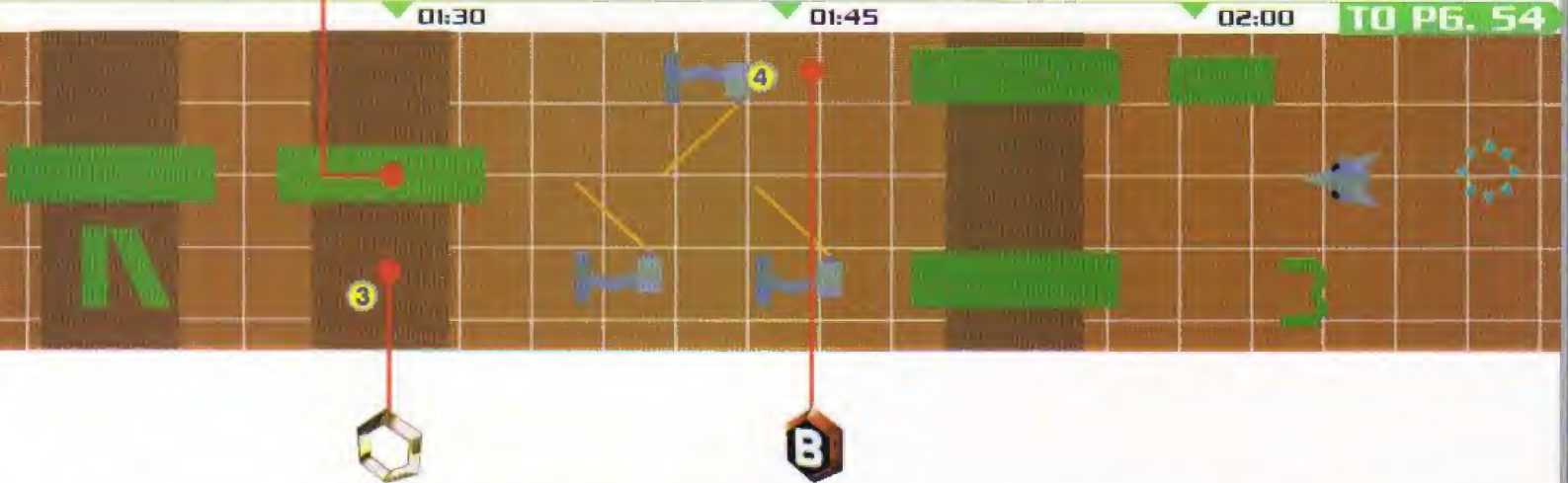

3 HOOP TO HOOP

As you approach the bridge, two Shield Rings, sitting side by side, tempt you to choose between them. Which one should you go for? You can easily capture both gold rings by first driving through the ring located on the bridge. As soon as you enter the ring, quickly barrel roll into the trench on your right to claim the second Shield Ring.



4 BOMB ON RIDGE



As you zip through the valley to escape the persistent laser rays that are tracking your Landmaster, hover up to the left ridge. A Smart Bomb waits for you at the end of it, but Titanian turrets weave a web of laser beams to tangle up your tank. Boost yourself speedily along the ridge to stay ahead of the laser fire and blow away the cannons, then plow forward to claim the bomb for your arsenal.

1

THE TIMBERLINE



A line of falling columns will threaten to flatten you when you attempt to claim the gold ring. The first four poles will fall to the right, the fifth will fall away from you, and the sixth will remain standing. Avoid getting pancaked by swiftly veering to the right of the danger zone. Once you've intercepted the ring, hover above the fourth fallen pole and land behind it to add a Smart Bomb to your inventory.

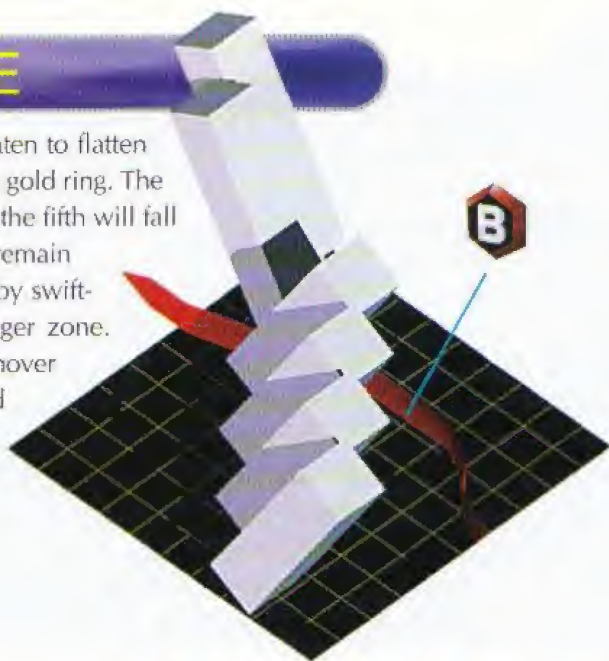

FROM P6.53

02:15

02:30

02:45

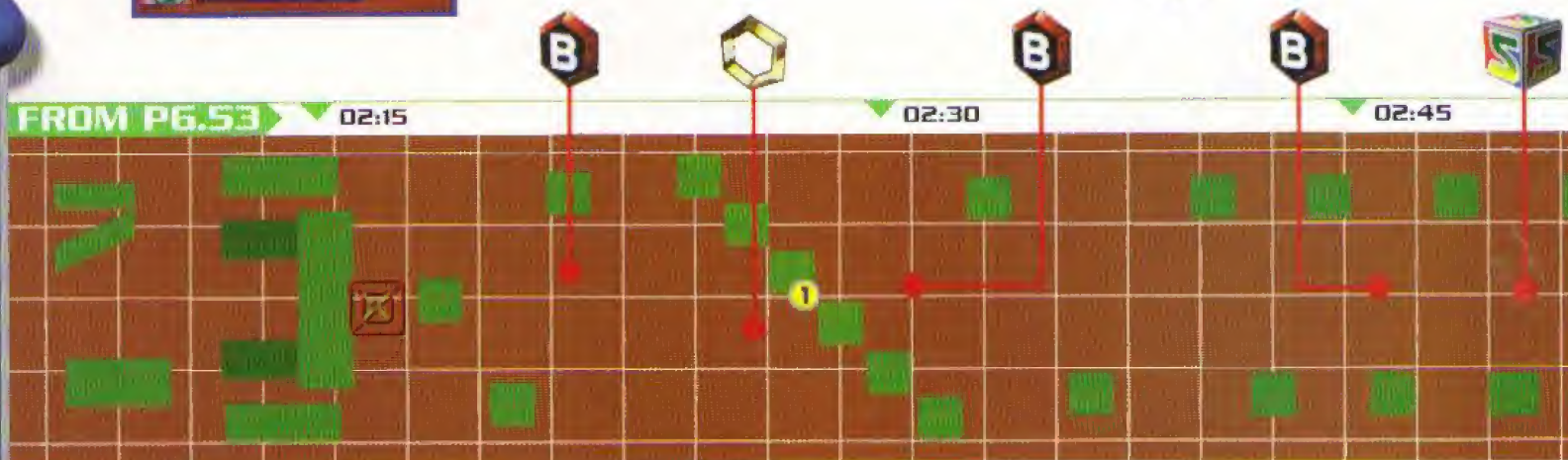

LOCK ON



DAINGEROUS SKIES

To earn easy hit points, aim high to down enemy aircraft—the ships are busy battling Arwings, so they pose little threat to you on the ground.



MAYDAY

Falco complains that he can't shake the bogey on his tail. The hotshot bird can outfly him, though, so don't worry if you can't target his enemy shadow. Instead, rack up hit points by firing into the clouds to diminish the squads of ships swarming above.



2 HOVERING FOR THE RING



In the valley, boulders, lasers, missiles and mines assault your tank. A much needed Shield Ring overlooks your plight from atop the gauntlet's right ridge. It's a tough climb that may take time and a few tries to conquer, so buy yourself as much time as you can by hovering up the hillside as soon as you spot the ring.

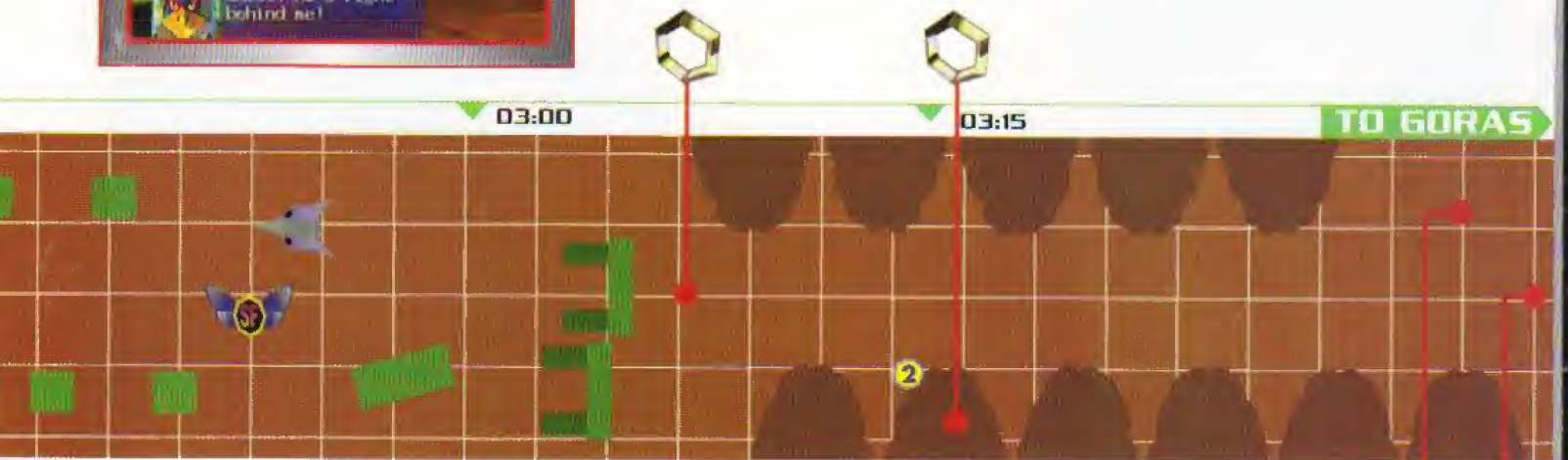

GORAS

Slippy crashes his Arwing straight into the clutches of the many-limbed Goras. To rescue your companion and free him from Goras's blistering grip, sweat it out in a heated battle with the ancient, wiry desert dweller and endure its clobbering punches, scorching laser missiles and ghastly monster breath.

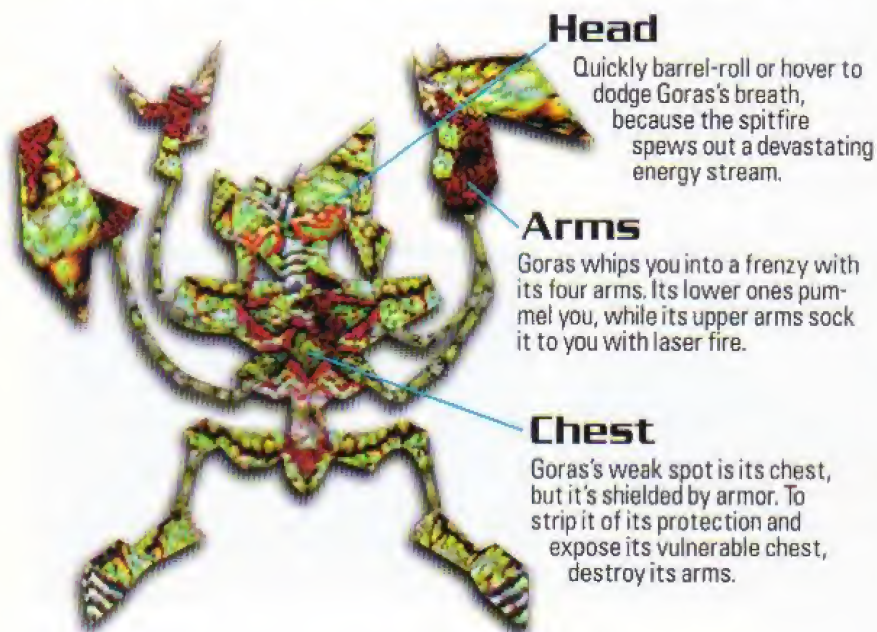

Goras grips Slippy's ship in its upper right arm. If you blast the other three arms, Slippy will be able to fly away.



Goras's punches pack quite a wallop, so quickly barrel-roll your tank to dodge its swings.



To avoid Goras's fiery breath, hover or boost to avoid the jet stream.



Once you shoot its arms off, launch bombs at its weak spot inside its rib cage.

Mission 6

150 hits

BOLSE



TO VENOM 1 CHALLENGE

A successful mission on Bolse throws you out of the frying pan and into the fire. Destroying the defense outpost leads you and your team directly to Venom, Andross's homeworld.



Andross's super defense satellite, Bolse, is the last line of defense before you reach Venom. We don't have a lot of information about this satellite since none of the scout ships we've sent there have ever returned.

A powerful force field protects it from remote scanning and makes the weapons of a large capital ship useless against it. A small strike team of fighters, such as your Star Fox team, might be able to bring down the force field and attack the core. Watch out for the Star Wolf team—they are sure to be on the prowl this close to Venom.

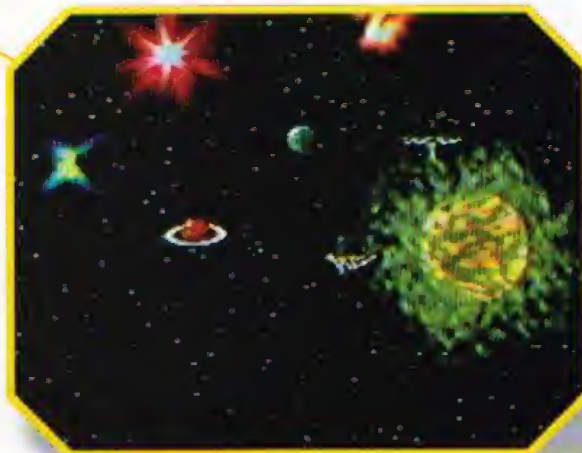

THE DEFENSE OUTPOST

The heavily-fortified Bolse Defense Outpost houses squadrons of armed airships to ensure that no invaders infiltrate the dark planet of Venom. The formidable fortress patrols the airspace surrounding Andross's homeworld in a slow but watchful orbit. Fly in All-Range Mode to destroy the ominous space station, its

armies of Bolse fighters and the Star Wolf team, but steer clear of the outpost's energized force fields. The defense satellite is powered by its towering core, and destroying this unstable source of energy will be Bolse's folly. However, laser cannons, energy rays and enemy aircraft savagely rage to protect its safety.



Station Data

- Radius.....20,000 sm
- Mass.....40,00 smt
- Core Rating.....7.59 bsp
- Fuel.....Compressed H₂
- Weapon Range.....8,000 sm

Astronomical Data

Bolse is an artificial satellite created by Andross to defend Venom. Because of the size of this structure, and the magnetic energy generated by its force field, it is surrounded by a strong gravitational field. A classified design document obtained from Andross's archives reveals that destroying the six generator pylons will neutralize its force field.

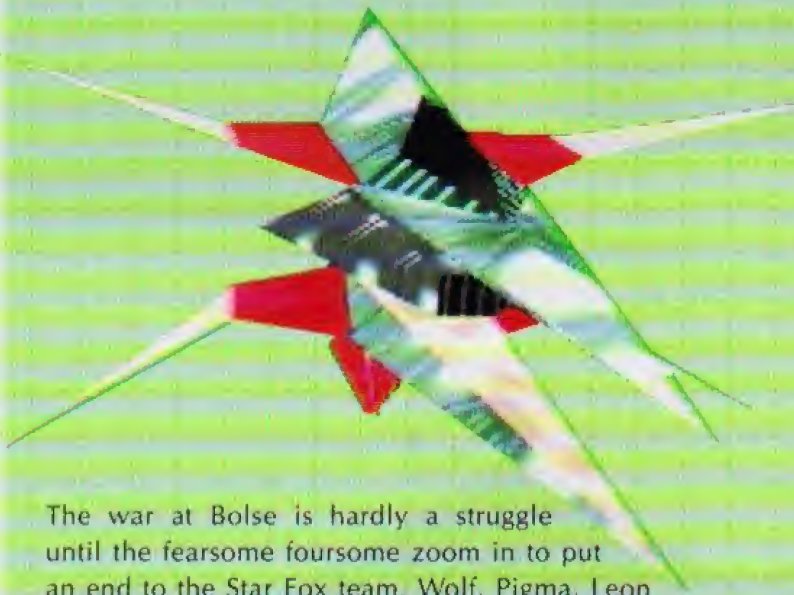
**ENEMY RECON****Star Wolf Team**

The war at Bolse is hardly a struggle until the fearsome foursome zoom in to put an end to the Star Fox team. Wolf, Pigma, Leon and Andrew know that they're the only ones who are left to stop you and your team from reaching Andross's home on Venom. They're not about to fail their boss, so they'll tail your Arwings like a vapor trail. Stay undaunted and rabidly dogfight your rivals, because their demise is your ticket to scoring at least 150 hits. Once you've started to disable Bolse's core, the battlefield will become frenzied with laser fire, so concentrate on downing the Star Wolf team before focusing your efforts on destroying Bolse. "Playtime is over," Wolf taunts. Make those his last words.

Shield Reactors

To power Bolse's force field, shield reactors radiate energy beams to the base. Flying into the energy rays damages your ship, so make the airspace more navigable by blasting off the tops of the six reactors encircling the base. Each disarmed reactor earns you four hit points.

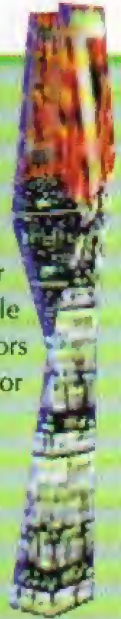
**Bolse Fighters**

The swift-flying Bolse fighters are aces at tailing the Star Fox team. Sharp turns and loops may shake some, but there are plenty more that will take up the chase. From their stations inside Bolse, the fliers spew out in countless droves, firing their lasers to keep you from reaching the core.

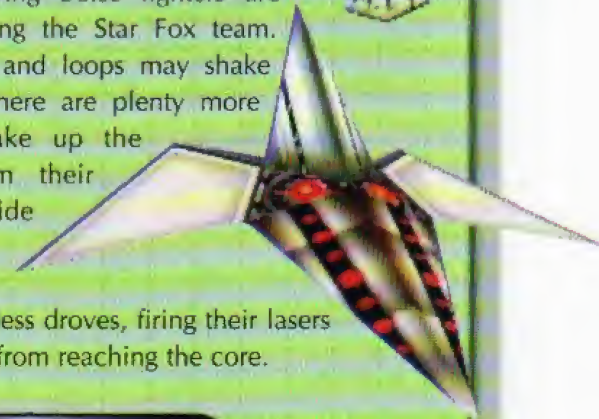
**Laser Cannons**

Bolse's airspace quickly becomes flooded with hyperactive laser fire. The laser cannons compound the assault by spraying their firepower across the surface of Bolse. It's easy to get blasted, but luckily for you, a bonus item appears in place of every destroyed laser cannon.

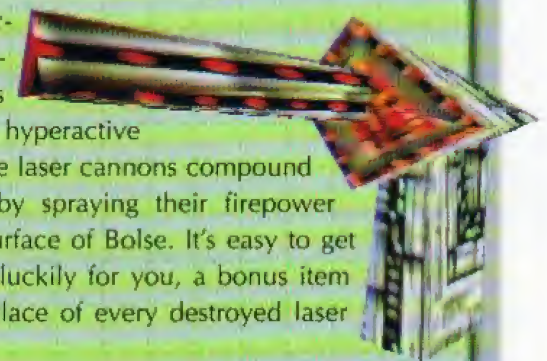

BLASTING REACTORS



To disarm the base's force field, you must destroy the reactors generating its energy. First, however, fly low and destroy the laser cannons flanking them. When you zap them, they'll turn into bonus items that will swiftly float along Bolse's surface, so stay low and fire up your boosters to intercept them. After destroying the cannons, shoot at the reactor's top portion to disarm it. Once you've deactivated the shield, prepare for the Bolse fighters to assault you.



The laser cannons usually give up Supply Rings, as shown on the map, but you may receive a Shield Ring or a Laser Upgrade depending on the condition of your ship.



INSIDE THE BULWARKS OF BOLSE

Bolse is Andross's last bastion of defense that keeps watch over Venom while still keeping its sights aimed at Corneria. Stockpiled with missiles and Venom armies, the artificial planet orbits around Venom, recklessly blasting away any oncoming fleets. Powering the massive space station is Bolse's bionuclear core. While the core generates immeasurable power, its unstable fusion of biomutated energy and nuclear power turns Bolse into a ticking time bomb. Therefore, six reactor pylons must constantly cool and stabilize the generator, or else Bolse's core will undergo bionuclear meltdown.

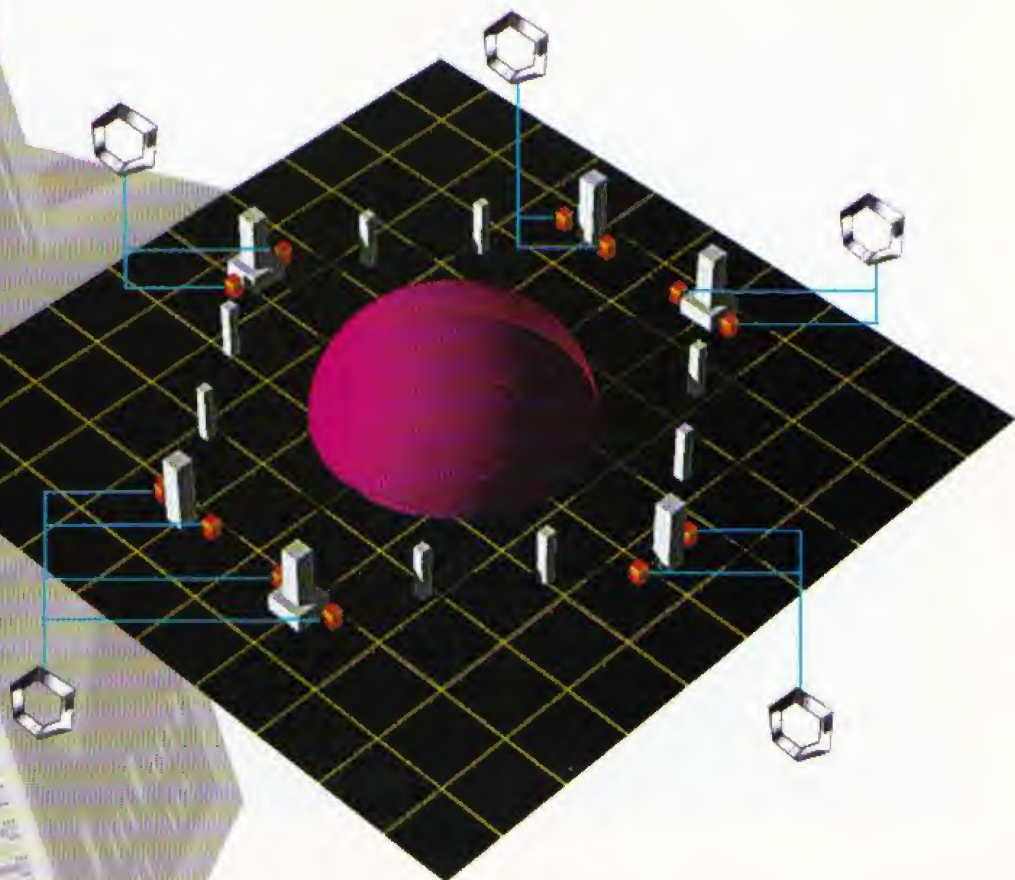

BOLSE CORE

After dogfighting on Bolse, the spinning core will eventually emerge from the base. Blast the eight panels adorning Bolse's core to blow up the space station. It takes a few hits to destroy panels, and you can't lock on to them, so give yourself some distance when commencing your attack. Apply your brakes and rapidly fire away as you approach the core.

Core Planets

The weak spots are the eight yellow panels. A few shots will destroy one, but it won't be easy to do since the core constantly rotates the panels out of the line of fire.

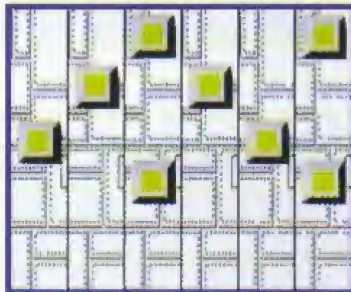

When the tower emerges, fire at the eight yellow panels to destroy the core.



Destroyed panels unleash laser fire, so the more you destroy, the harder it'll be to safely approach the core.



Fire away! You'll earn up to 11 hit points for each one you blow up.

DETOUR OF DUTY

BATTLE OF THE BOLSE

Not only do you have to battle swarms of Bolse fighters, but you'll have to tangle with the Star Wolf team, too. Mission 6 has no time limit, so go for the hit points and destroy all enemies before targeting the core. If your Arwing gets crippled, blow away the laser cannons to power up your ship with bonus items.



Mission 7

150 hits

SECTOR Y



1 TO KATINA CHALLENGE

If you score less than 100 hits, you'll head to Katina to fight alongside your former classmate, Bill Grey. Aided by his Husky unit, you'll doggedly defend the front lines of the Katina base.



Comeria's main battle fleet has suffered severe losses in Sector Y! A huge space battle has left our flagship crippled—or perhaps worse. Debriefed survivors have informed us about a new attack squadron of gigantic, humanoid battle suits in the area. Although it may be too late to rescue our fleet from disaster, we need you to get in there and take out Andross's new iron soldiers! Their shields will deflect anything but a direct laser hit, so aim carefully! They are, of course, accompanied by starfighters that will keep you on your toes.

2 TO AQUAS CHALLENGE

Aquas is the only area where you can venture underwater for some deep-sea destruction in the Blue-Marine sub. To enter Davy Jones's locker, reel in at least 100 hit points in Sector Y.



YOU SANK MY BATTLESHIP!

In the Sector Y combat zone, Andross's intergalactic warships troop straight into Comeria's defensive wave of space battleships. Enemy missiles are dropping General Pepper's ships like rocks in a heavy meteor shower. Inside enemy lines, the confusion of enemy battleships floating through a grave-

yard of Comerian vessels creates a maze of obstacles that you must navigate using swift aerial acrobatics. Equally agile is Sector Y's biggest menace—a flying robot infantry. Spare the Comerian front from Andross's threat by penetrating his offensive and disabling his battleships and troops.



Sector Data

- Radiation.....5.61 ergons
- Mag Flux.....38%
- Particle Density...45 c/sg
- Average Albedo...59
- Approx. Radius.....17,364 skm

Astronomic Data

A great cloud of space dust has formed in the shape of the letter Y in this sector. As in Sector X, there is strange radiation and magnetic waves in this area, but the fluctuations are not as severe. Casual travel through the area is still not recommended.



ENEMY RECON

Dorisby

Andross's mug adorns the front of the Dorisby. Even uglier are the ship's turrets that zero in on your Arwing. The Dorisby, like all battleships in Sector Y, cannot be sunk. However, it can be disarmed. Blast the turrets, and, for extra hit points, shoot at the black and yellow bunkers on the ship's sides.



Saruzin

The flagship of the Sector Y offensive is the Saruzin. Aboard it is the Shogun warlord, the guardian robot that oversees Andross's galactic fleet. You can easily target the robot when it stands on the ship's deck, so attack it there before it launches itself off the runway.

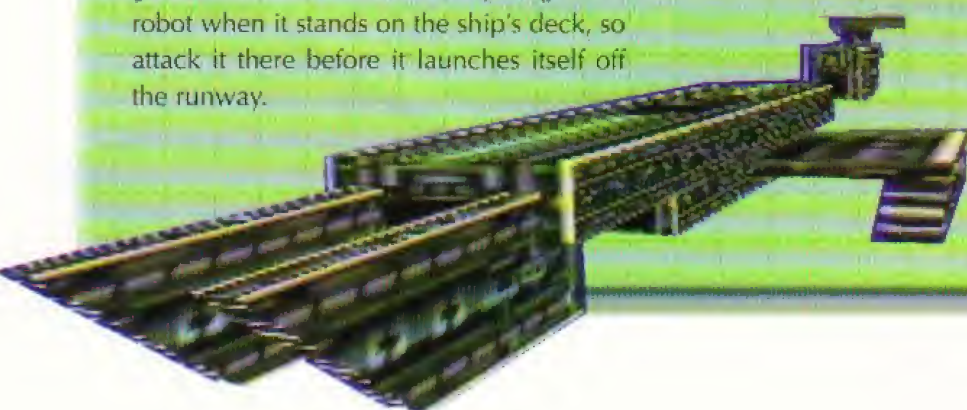

Grazan

The Grazan's dual hulls are open in the front like a double-barreled shotgun. Aim your sights on these openings, but steer clear of them, because not only do they launch attackable armies of assault craft, but they also fire batteries of unstoppable energy bolts.

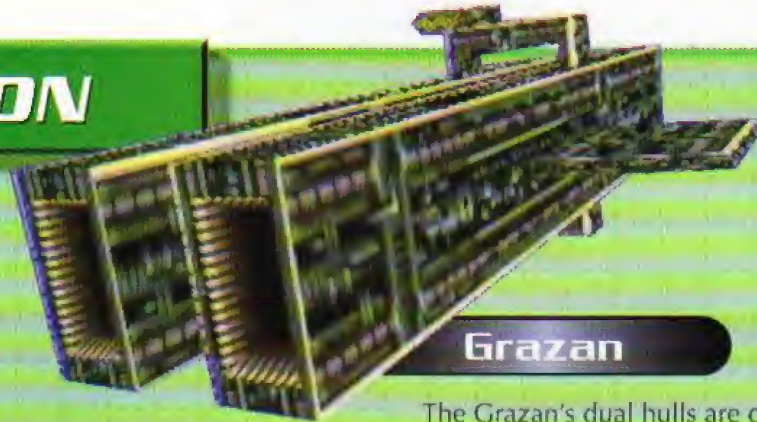

Small Missiles

The battleships spray the combat zone with piercing torpedoes that home in on your Arwing. The small missiles usually blaze their sweeping, explosive swath. You can't lock on to them, but if you're a sharpshooter, you can destroy them with charged laser fire or bombs.



1

DOUBLE WHAMMY



As you approach the Grazan battleship, target its openings, because fighters will catapult out of both barrels. Lasers simultaneously spew out, too, so quickly veer to safety. After the assault, you can fly either above or below the ship's deck. Both paths deal you the same enemies: a squad of enemy fighters. The fliers appear at the end of the Grazan,

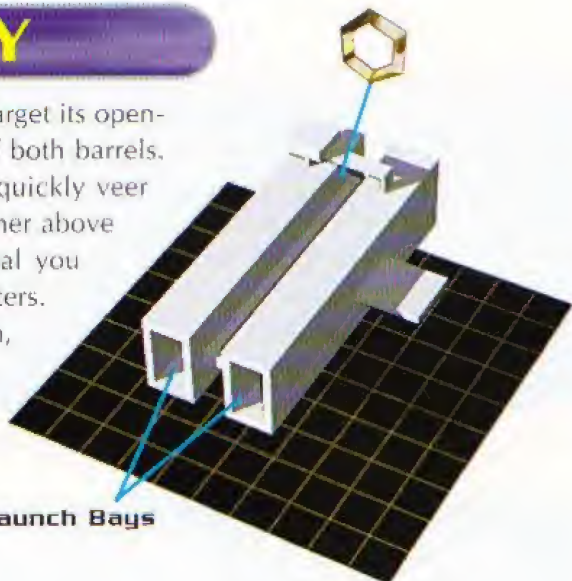

so keep your lasers charged.

**Launch Bays****B**

Annihilate the entire squadron of enemies to make a bomb appear for your valor.

Defeating the flock of fliers zooming through the Grazan earns you a Shield Ring.

**START**

00:15

00:30

00:45

01:00

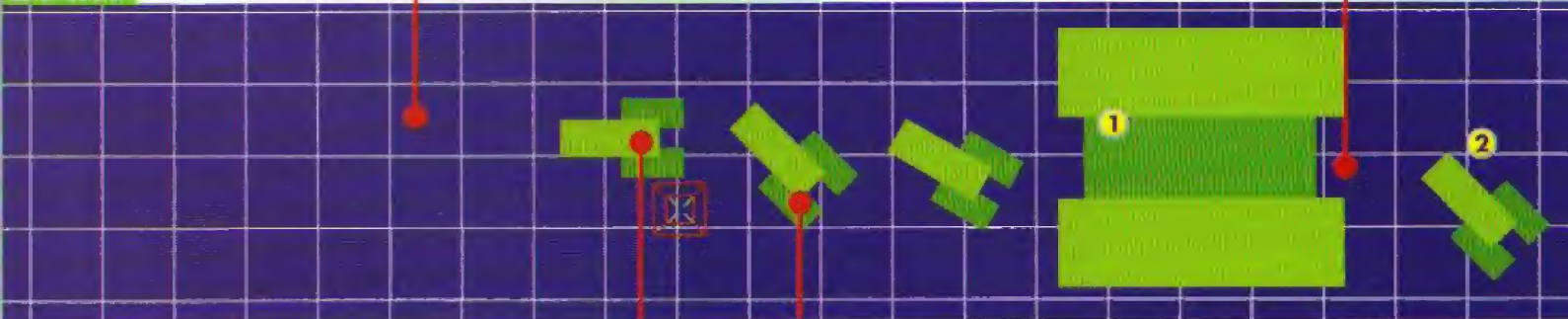

Zap the last robot soldier floating by the battleship to earn a Laser Upgrade.



LOCK ON



LOCK ON THE BOT

The robot soldiers may have shields, but they can't withstand a hit from your charged laser. Lock on to a robot, then fire. It

takes only one hit to overload its circuits and explosively crash its system.



2 FAREWELL TO ARMS



The cannons mounted on the battleships easily elude your Arwing's targeting system, so you'll usually have to fly in fairly close in order to get a lock on the turrets. Such confrontational tactics make you an

easy target, so rather than waiting to get a lock on your target, fire away and pelt the cannons with your lasers.

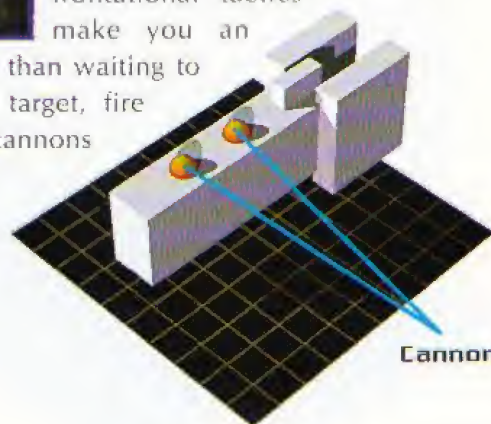
**Cannons**

3 REAR ATTACK

As soon as Peppy Hare warns you that enemies are soaring in from behind, apply your brakes or perform a loop to let them pass. Be as quick as the rabbit who's dishing out the advice, or else the enemy squad will plow into you with their ships and laser fire.



01:15

4 OVER OR UNDER?

You have two routes to choose from, depending on whether you swoop above (Route 1) or below (Route 2) the Grazan carrier to pass it. The lower route is the more hazardous path, flying you directly into the line of cannon fire and robot troops. If you vie for the upper route, you'll encounter plenty of enemies that can easily boost your hit points over 100.

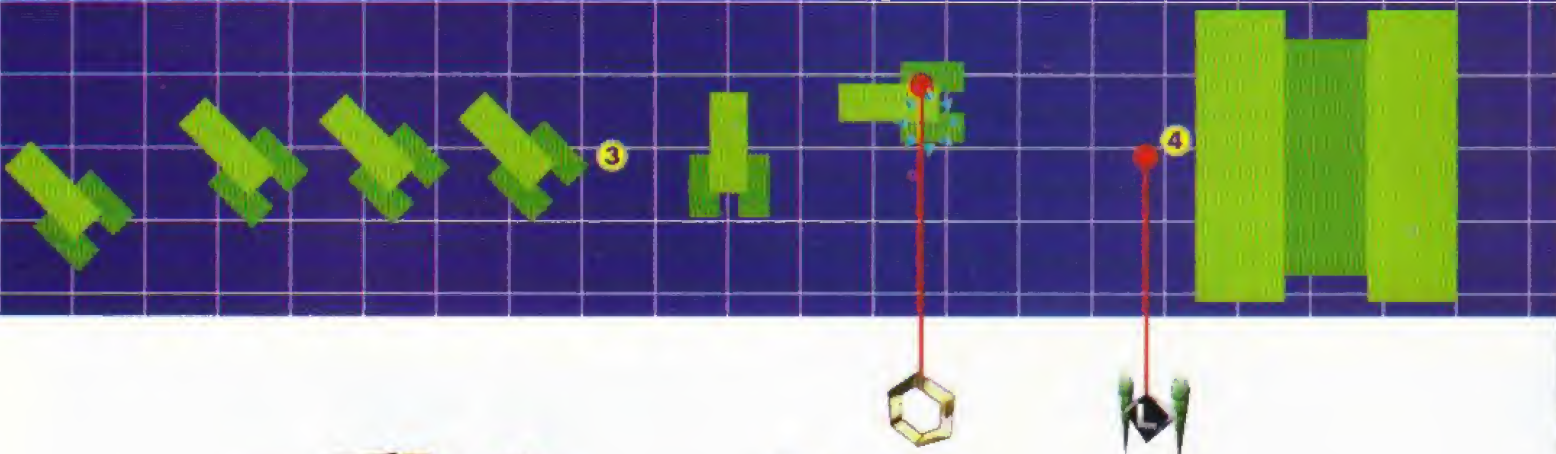

01:30

TO ROUTE 1 OR 2 PG. 64**LYLAT DATALINK****THE BATTLESHIP GRAVEYARD**

Sector Y is a mysterious zone haunted by conflicting storms of radiation and magnetic energy. The space dust that ionizes the sector tends to cause the equipment of most space craft to malfunction or fail. Sector Y renders most ships helpless, leaving them victims to space pirates and Venom's armies. Usually, pilots wisely steer clear of the eerie vacuum, but those who dare to enter rarely escape. Scientists attribute much of the existence of the Sector Y phenomenon on a failed Bolse satellite prototype that underwent a nuclear meltdown and polluted the zone with its radioactive remains.

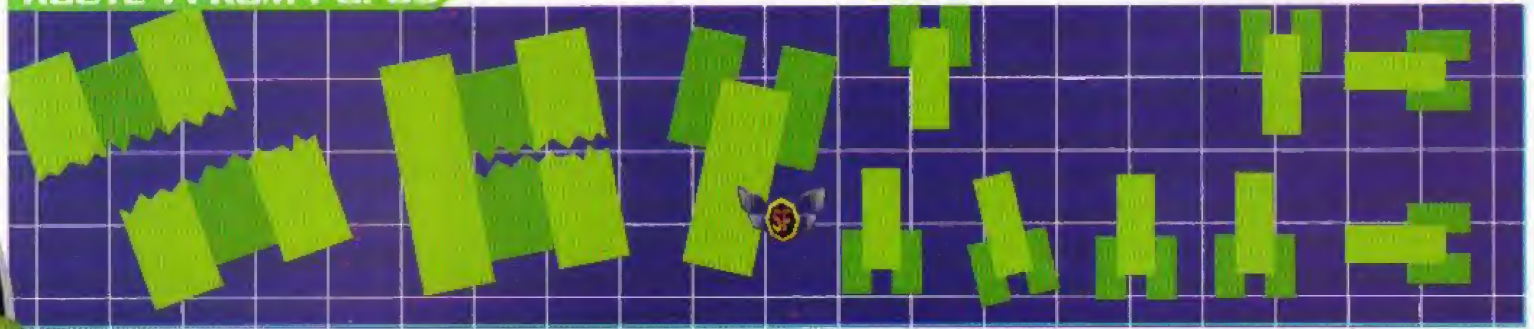

MAYDAY

When Slippy croaks, "Hey! Leave me alone!" aim your sights to the right and fire above the deck of the wrecked ship to exterminate the swarm of airships that are buzzing in the distance.



LOCK ON



MECH TROOPER



The red robot is tougher than the other robot soldiers you've fought so far. It jets around a lot, so it's hard to hit unless you lock on first. At least two charged laser blasts should destroy it.

For a Laser Upgrade, lock on and zap both robot soldiers.

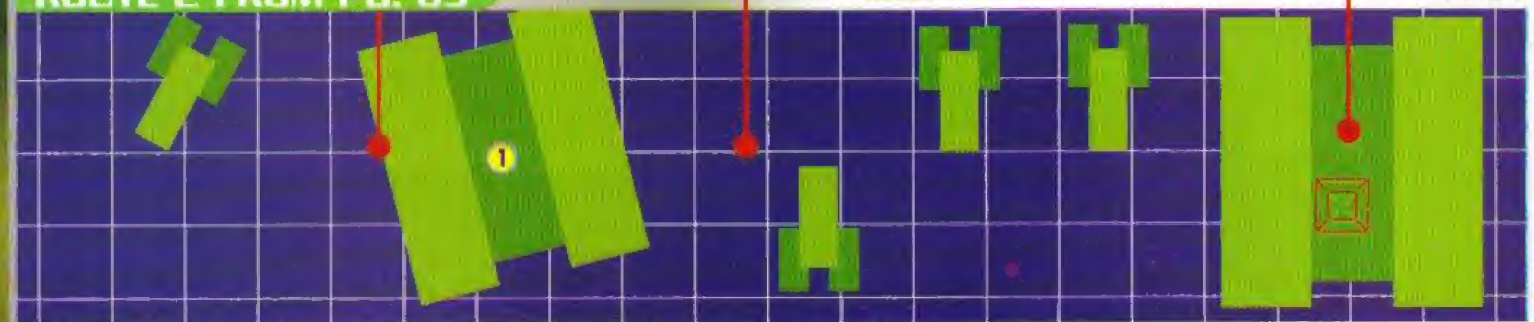

1 CROSSING THE CARRIER

As you fly toward the carrier, its laser cannons will draw a bead on you and launch a steady stream of laser missiles in your direction. As long as you keep moving, you should avoid getting zapped. Before returning fire at the cannons, lock on to the robot soldier taking off from the ship's runway. After shooting it down, swoop left to blast the cannons and the second robot soldier.



SHOGUN

Before you duel with the Shogun warlord, you must first defeat a pair of Shogun warriors. The robotic duo, which is worth a total of eight hitpoints, bullishly charges you and assails you with pistol fire. The warlord's combat tactics are similar, but its strong armor, protective shield and agile maneuvers make it a far fiercer foe.



When you fire at the Shogun warriors head-on, they usually retaliate by charging, so be prepared to swerve.



After you beat both warriors, the Saruzin battleship will launch the warlord to spar with you.

Gun

The warlord is armed with a high-powered laser gun. One hit can considerably damage your Arwing, so avoid being an easy target by constantly moving.

Shield

The Shogun warlord deflects lasers with its shield. To destroy it, relentlessly blast away at it with your lasers.

Follow your wingmen closely as they fly in formation for an upgrade. If you have twin lasers already, you'll get an extra ship.

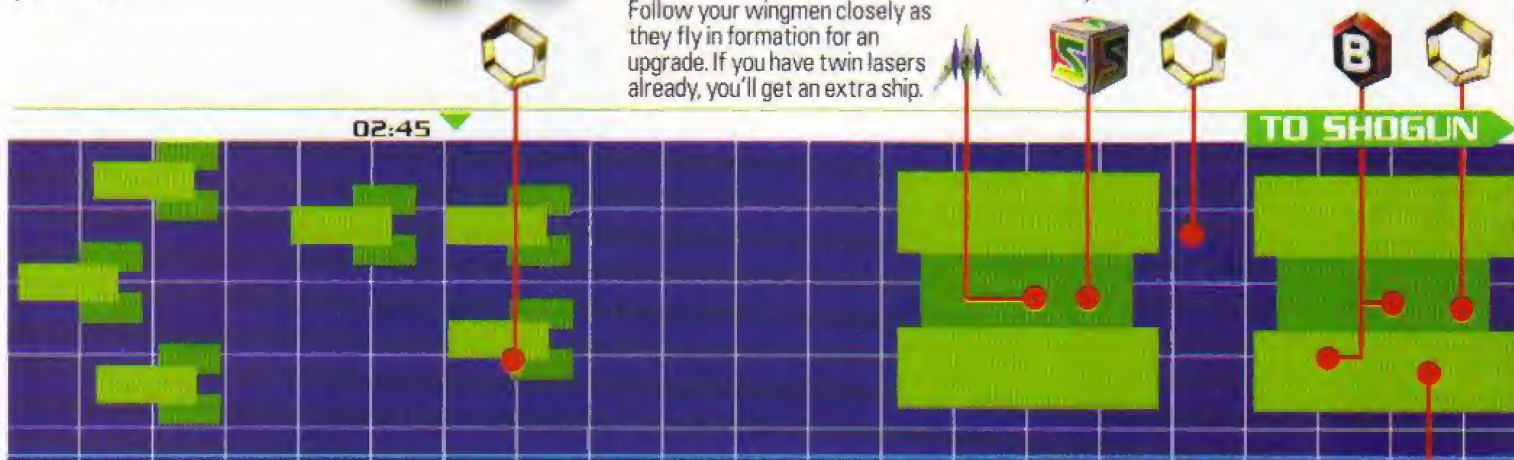

DETOUR OF DUTY

SCORING 100 HIT POINTS

To maximize your hit points, fire away at all of the battleships' cannons and bunkers. You'll need at least 81 hit points entering the final showdown, since destroying the Shogun robots can earn you up to 19 points.

100 HITS OR MORE

If you score 100 or more hits upon completing your mission in Sector Y, your next mission will submerge you leagues under the sea on Aquas. To rack up enough hits for the dive, take the upper route when the carrier throws a fork into your flight path.

99 HITS OR LESS

If your targets elude you and you earn less than 100 hit points, you'll journey to Katina to reunite with your old pilot pal, Bill. Other than Meteo, Sector Y is the only mission that will lead you to Katina to join forces with Bill and his Husky unit.

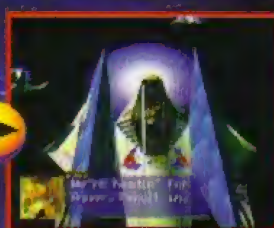

TO AQUAS PG. 84

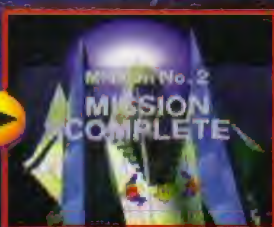

TO KATINA PG. 66

Mission 8

150 hits

KATINA

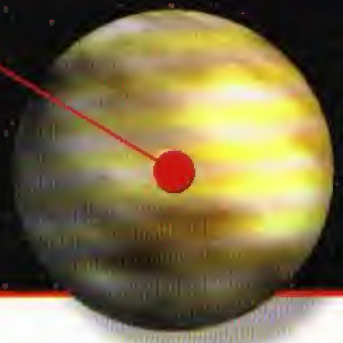

1 TO SECTOR X CHALLENGE

If you can't save Katina's base, the Star Fox team will be routed to the Sector X Nebula. The battle in Sector X is easier than the one in Katina, and it's a step closer to the confrontation on Venom.



Katina is one of our frontline defense posts, Fox, and it's being overrun by Andross's fighters.

We received a distress call from your academy classmate, Bill Grey, who is in command of Husky Squadron. Apparently there are hundreds of fighters swarming over the base! Bill has also informed us that an enemy mother ship has been detected on its way to the planet. Get over there and help him out before it's too late! Bill will brief you more fully on the gargantuan mother ship when you get there, so listen to him carefully!

2 TO SOLAR CHALLENGE

A dwarf star, Solar is the undisputed hot spot in the Lylat System. You'll warm more than your toes here if you successfully defend Katina's base and eliminate the enemy invasion force.



THE SIEGE OF KATINA

The Star Fox Team will defend Katina in All-Range Mode. The skies are swarming with dogfighting aircraft and it's difficult to discern friend from foe. As the battle rages, Saucerer, a heavily fortified assault craft, will appear and make an attack run at Katina's Frontline Base. While clouds of enemy fight-

ers will pour out of Saucerer, the biggest threat is the ship's Core weapon. It takes sixty seconds for the Core to charge and vaporize a target. If you can destroy the Core weapon, the explosion will scramble the ship's delicate internal circuitry and set off a massive chain reaction.

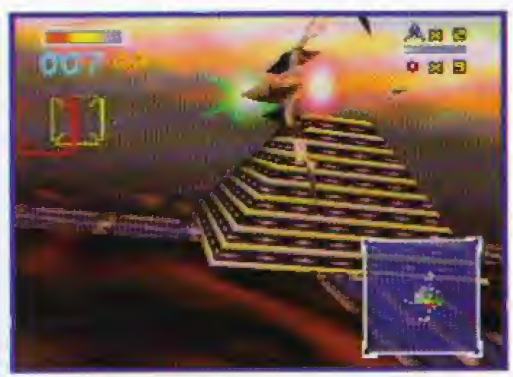

FLIGHT LOG

Planetary Data

- Radius.....4,893 skm
- Albedo.....0.37
- Gravity.....0.85
- Esc. Velocity.....9.45 skm/s
- Equilibrium K.....281
- Atmosphere.....N280.0217
- Hydrographics.....8%
- Biomass.....676 Quads
- Class.....0

Planetary Compendium

Although Katina has less water than Corneria, the climate and environment are quite similar. The planet was intended to be a colony for Corneria, but Andross's attack has halted immigration. The beleaguered Cornerian Defense Force is now nearly exhausted.



ENEMY RECON

Corneria Fighters

Corneria Fighters are not enemy aircraft, but many rookies mistake the aircrafts' markings for Venom's Invader Assault Fighters. Your Arwing combat computer can identify Corneria Fighters and will not lock on them.

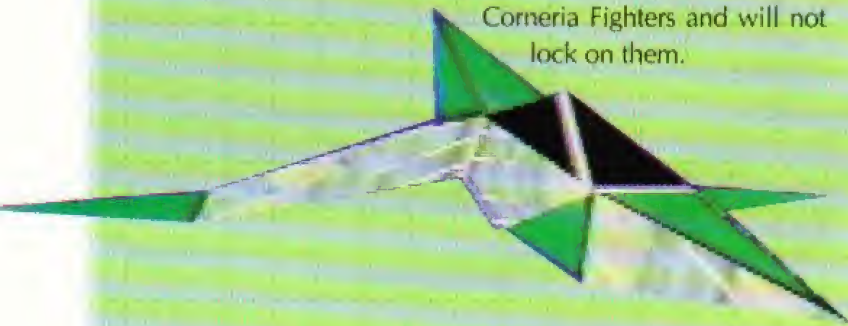

Katina's Top Guns

Katina's Frontline Base is home to some of the best fighter jocks in the Lylat System, including the decorated pilots of the prestigious Bulldog and Husky units. Since veteran pilots are in short supply, these aces are a prized asset to the Cornerian Fleet. General Pepper will be very disappointed if you accidentally shoot one down.



Invader II

Venom's Invader II Assault Fighters suffer from numerous design flaws and are vastly inferior to Corneria Fighters. To overcome their shortcomings, Andross has ordered all Invader IIs to be painted with Corneria markings to confuse the Star Fox team.



The Frontline Base

Katina's Frontline Base provides fighter support for the Corneria fleet against Venom's invasion fleet. The skilled pilots based here have been constant thorns in Andross's side. General Pepper has been anticipating an assault here for some time.

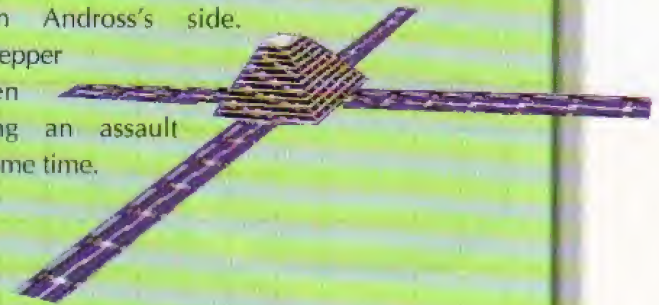

Bill Grey

Bill Grey is a squadron leader at Katina's Frontline Base. Bill and Fox go way back; in fact, they studied together at the Corneria Flight Academy. If you assist Bill and save Katina's base, it's a sure bet that he will find a way to repay the favor later on.





LOCK ON



LOCK ON TARGETS!

It's tough to identify the friends from the foes as they flash by your canopy, especially since the friendly and enemy fighters have similar paint schemes. Your combat computer knows the difference, so lock on each target.



LYLAT
DATALINK

ANATOMY OF AN INVASION

The invasion of Katina is a textbook example of a Venom assault. The first enemy objective is to establish air superiority. Since Andross's Invader IIs are inferior to Cornerian fighters, the enemy will overwhelm the defenders with huge numbers. As Saucerer flies over primary targets, air defense units are lured into meeting the first wave of Invader IIs. A larger wave of enemy fighters then swarms out of Saucerer and eliminates the preoccupied defenders. With the skies clear, Saucerer deploys its Core Weapon and commences with the second objective: the complete annihilation of hapless ground units. At the end of the battle, shock troops are dropped to enslave any survivors.

F
L
I
G
H
T
L
O
G

Saucerer



Once the Saucerer arrives, it will launch wave after wave of fighters. After you destroy two launch hatches, ROB will hail you for a resupply.

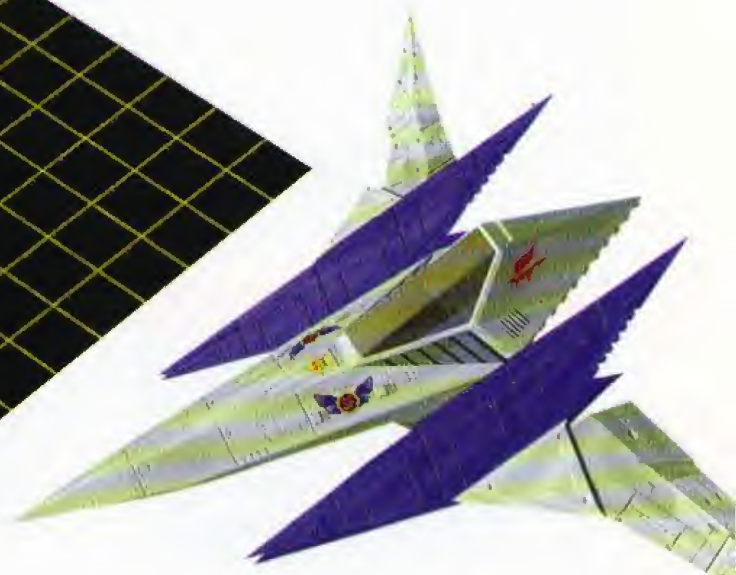
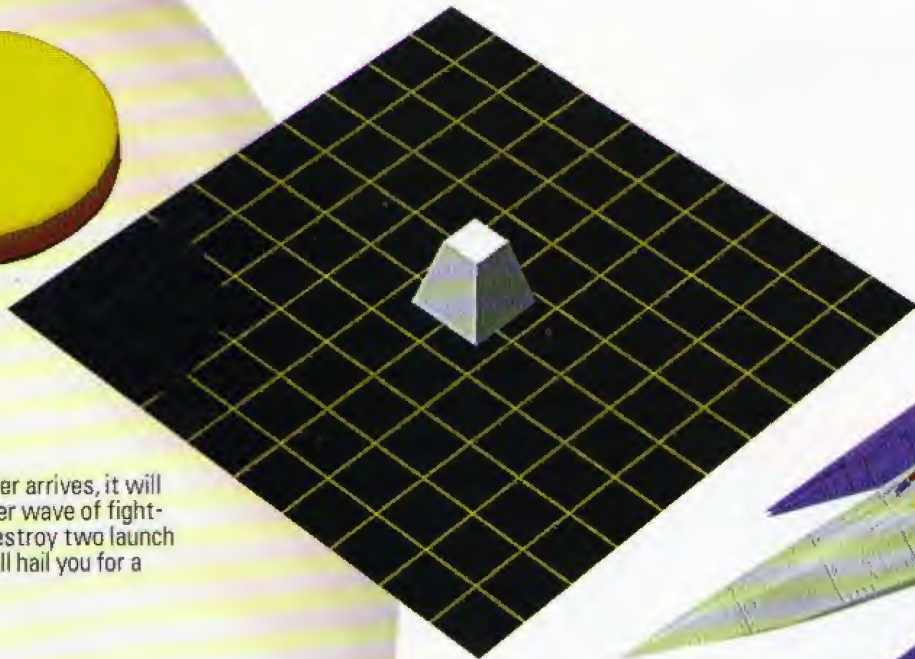

SAUCERER

It's rumored that Andross stole the plans for Saucerer from an alien civilization that lives far beyond the Lylat system. The Saucerer is a fortified assault craft designed for invasions. It carries several hundred fighters and is armed with a powerful Core weapon. Once fully energized, the Core weapon can discharge enough energy to vaporize any city in the galaxy.

The Hatches

Enemy fighters launch from four hangar bays, which are called "hatches" by Corneria's seasoned pilots. Destroying the hatches will stop the air assault on the base.

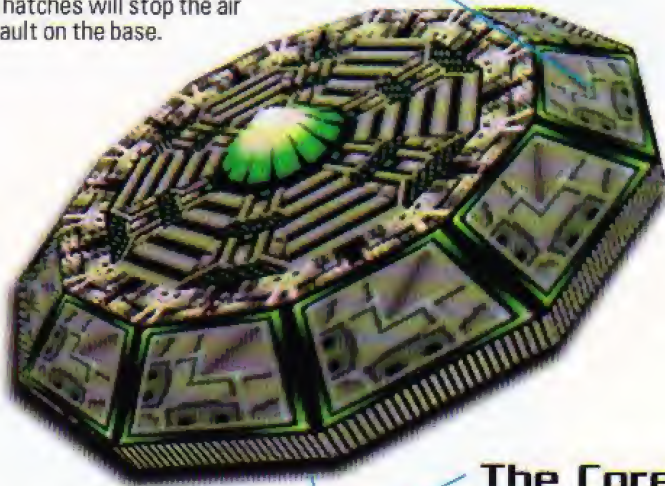

The Core

The Core is Saucerer's central power plant and main weapon. It takes sixty seconds for the Core to energize over a target. During this charging time, the Core is completely vulnerable to attack.

Saucerer's hatches aren't open all the time. Bill will radio you when the bay doors slide open.



Fly underneath Saucerer and use your laser to shoot away the hatches.

If you have Smart Bombs, apply your brakes and launch all of them at the Core.



DETOUR OF DUTY

SAVE KATINA BASE

Where you go next depends on whether you save the base or allow it to be blown away. Mission 8 isn't a milk run, so don't be surprised if Andross's legions slam dunk the Frontline Base. The key to victory is knowing the idiosyncrasies of All-Range Mode flying and being able to understand the data on your radar screen.

SAVE THE DAY

It's time to turn the tables on Venom's Forces. You can surprise the enemy by attacking their supply center. Their sensors won't detect you if you fly through Solar's orbit. When you destroy Saucerer's Core, Katina's inhabitants will see the greatest fireworks display in the planet's history.



TO SOLAR PG. 70

KATINA IS VAPORIZED

If you fail to destroy the Core within sixty seconds, Saucerer's Core will discharge and vaporize the base. A surprise attack on Macbeth is no longer an option since Venom's forces are regrouping in the Sector X Nebula. Perhaps you can vanquish the enemy forces gathered there.



TO SECTOR X PG. 44

Mission 9

100 hits

SOLAR



TO MACBETH CHALLENGE >>>

Andross and the forces of Venom aren't expecting a Cornerian attack from Solar. A fighter jock would have to be as crazy as a fox to attempt a fly-by orbit around this volatile sphere.



Scientists have been saying for years that nothing could possibly live on this star's surface, but we've scanned Andross's ships going to and from the star. Only he would be so foolhardy as to try to find military benefit in exploiting a red dwarf like Solar. It's another situation we need to have you to check out for us, Fox. Nothing in the Cornerian armory can withstand the extreme temperatures near the surface of this star, but your Arwings should be able to make it.

A FOX IN THE FLAMES

While your Arwing's hull is built to withstand temperatures in excess of 9,000 degrees, the heat on Solar's photosphere exceeds all intergalactic engineering safety standards. Only your ship's shields prevent you from being broiled. Your shield energy gradually decreases as you brush the flames

of Solar's endless inferno. The lower you go, the faster the shields burn. Fortunately there are more Supply Rings on Solar than any place in the Lylat System. Shoot the lava rocks and flying enemies, then replenish your shield energy by flying through the Supply Rings that appear in front of you.



Stellar Data

- Radius.....8153 skm
- Gravity.....32 mG
- Temperature.....3,500 degrees k
- Energy Output...6.947 ergons
- Stellar Class.....M

Planetary Compendium

An M Class star, Solar is in the middle of Lylat's Sector X-Y-Z Triangle. Until Andross began his bioweapon experiments, scientists never believed that life could exist on a star, even with Solar's relatively low surface temperatures. Andross may have introduced life here to spite his contemporaries.

**ENEMY RECON****Gores**

Flying fire birds called Gores soar on the superheated thermals radiating from Solar's hot surface. Considering the creatures' heat resistant properties, Lylat zoologists speculate that the genetic structure of the Gores is exceptionally advanced. Unfortunately, the beasts have the mental facilities of moths drawn to flames. Gores are extremely territorial and will chase and attack anything that flies too close to their feeding grounds.

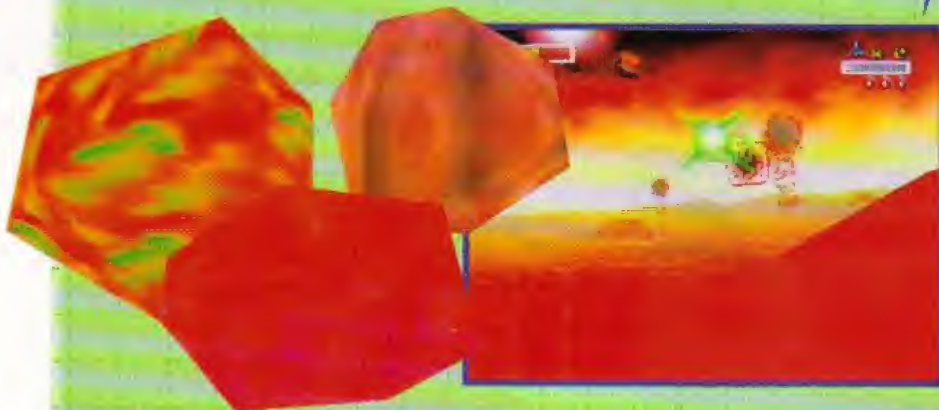
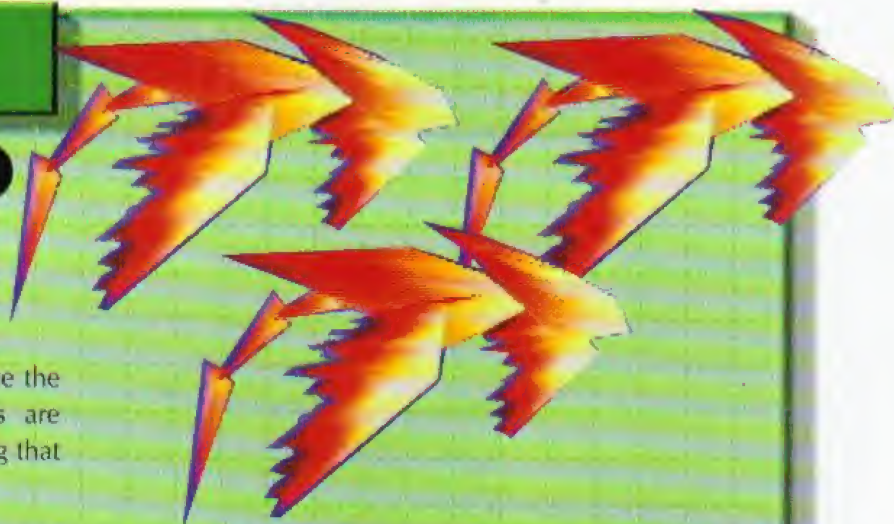
**Lava Bombs**

Solar's surface constantly spews burning rocks into space. While gravity reclaims most of these molten meteors, a survey crew once captured one and made a shocking discovery: the rocks are composed of former space junk. The minerals are recycled and forged by Solar's heat into Supply Rings, Supply Stars and Smart Bombs.

Solar Prominences

Solar Prominences are arches of incandescent gases that loop between the sunspots on Solar's surface. Prominences can spring up suddenly in front of your shields, giving you very little time to react with evasive measures. Your lasers have no effect on Solar Prominences, but the explosive blast from a Smart Bomb will evaporate the gases. Use your bombs wisely, since Prominences vastly outnumber your ordnance capacity.

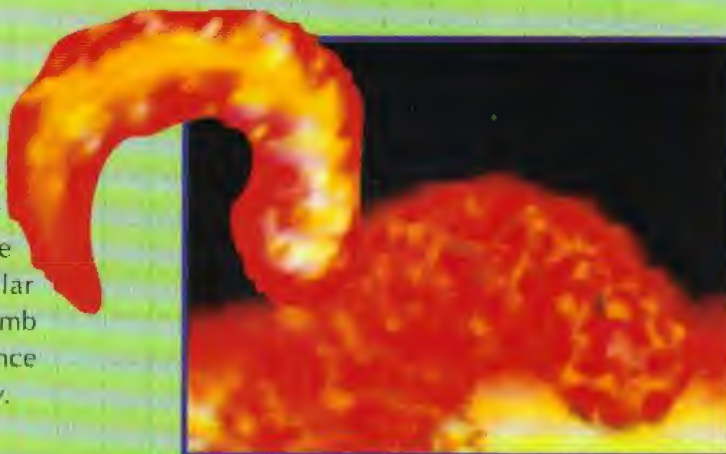

1 PROMINENT PROMINENCES

The curved arrows on the map indicate the paths of anticipated Solar Prominences. The searing heat from these expanding arcs of incandescent gases can eat up your Arwing's shields, so fly above or under each prominence. When taking the low road, remember to pull away from the surface as quickly as possible to avoid depleting your shields. If a collision is inevitable, launch and detonate a Smart Bomb in front of you to break apart the fiery gases.



START

00:15

00:30

00:45

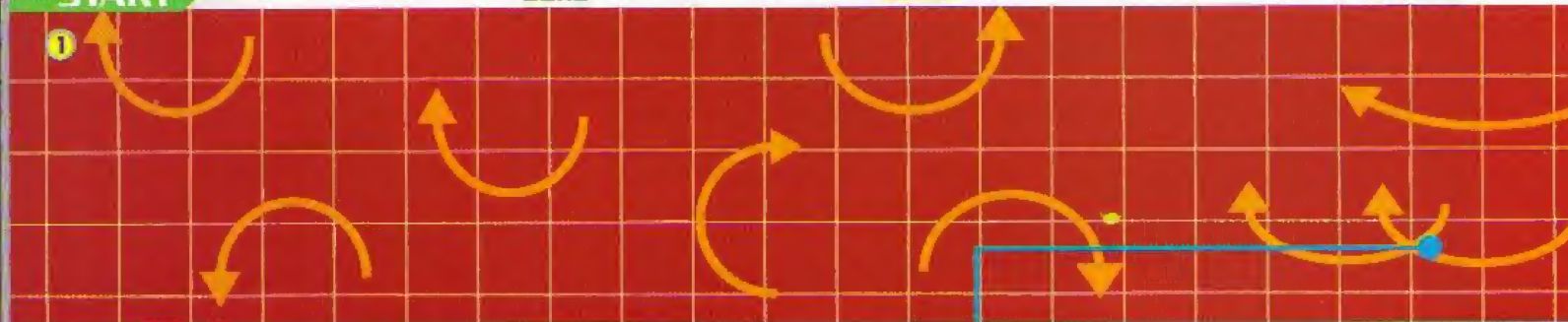

BILL TO THE RESCUE

Since you helped Bill Grey destroy Saucerer and defeat the Venom invasion force on Katina, he's determined to risk his life and repay the favor. Bill will swoop down in front of you during the first half of your sizzling journey across Solar's turbulent surface. If you follow his fighter through the searing heat, he'll drop Supply Rings and a Laser Upgrade in front of your Arwing. You'll use these provisions—especially the Shield Rings—to navigate the treacherous swells gathering on Solar's hot horizon.

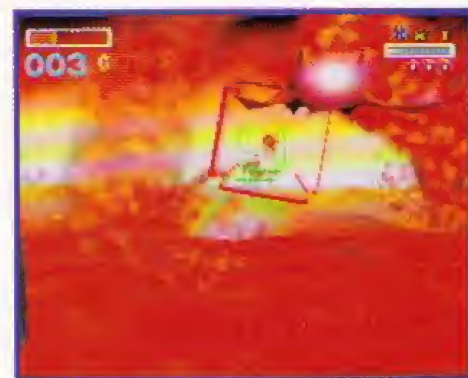

If your shields are nearly toast, look for the Shield Ring in the middle of this lava bomb field.

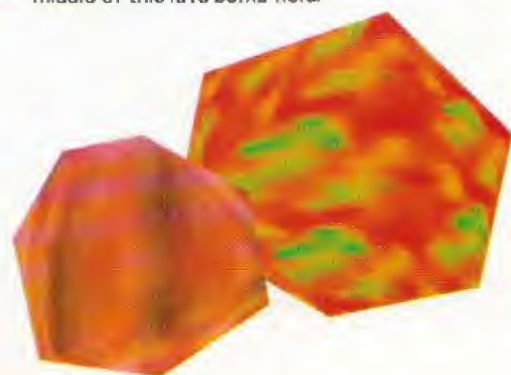

A FLOCK OF FIERY FOWL

For each group of Gores you gun down here, you'll earn a Supply Ring or other power-up item. These fiery fowl fly fast, but you can down an entire group with a solitary Smart Bomb. Depending on what you need and what you receive, blasting Gores can be either rewarding or a total waste of Smart Bombs. Check your ship's status before you decide to use up all your Smart Bombs shooting them down.

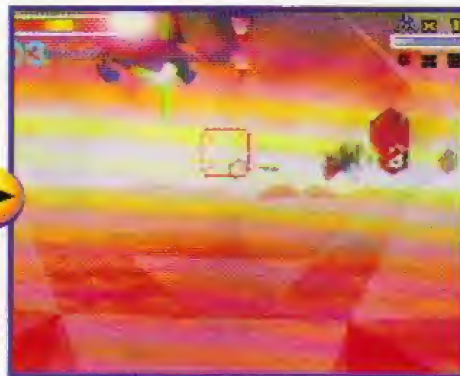

If you stay on the left of the solar swells you'll see a Gore you can shoot for a Laser Upgrade. Go right if you already have the hyper laser.

01:00

01:15

TO PG. 74

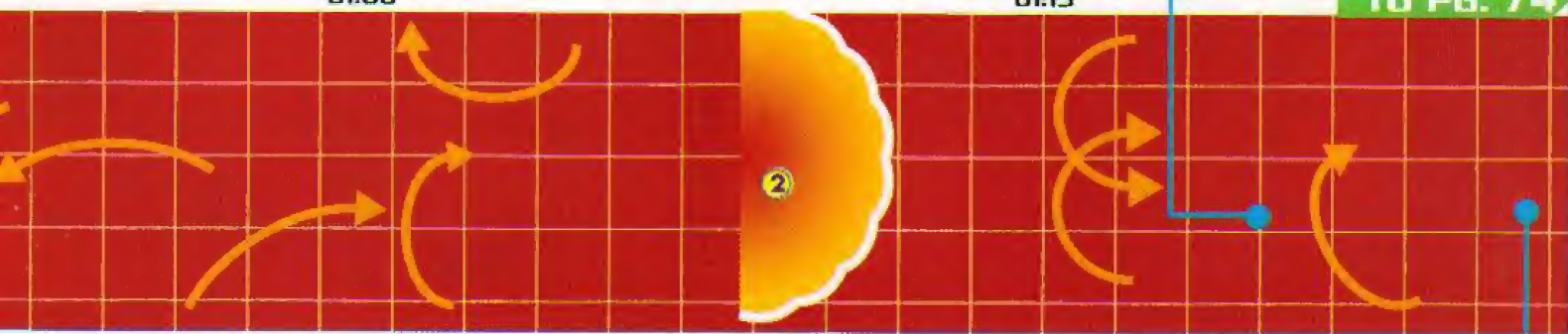

2 SOLAR SWELLS

It's a real heat wave! As you approach this turbulent region, titanic solar swells will rise and break in your path. Press the Z or R Button to tilt and turn your Arwing around the edges of these burning breakers. Solar Swells are just as hot as Solar's flat surface, so try to keep as far away as possible from the waves or your ship's shields will quickly disintegrate.



If you veer to the right and down the Gore here, you'll pick up two Smart Bombs and a Shield Ring. Save the bombs for the Prominences.

Sharp Left

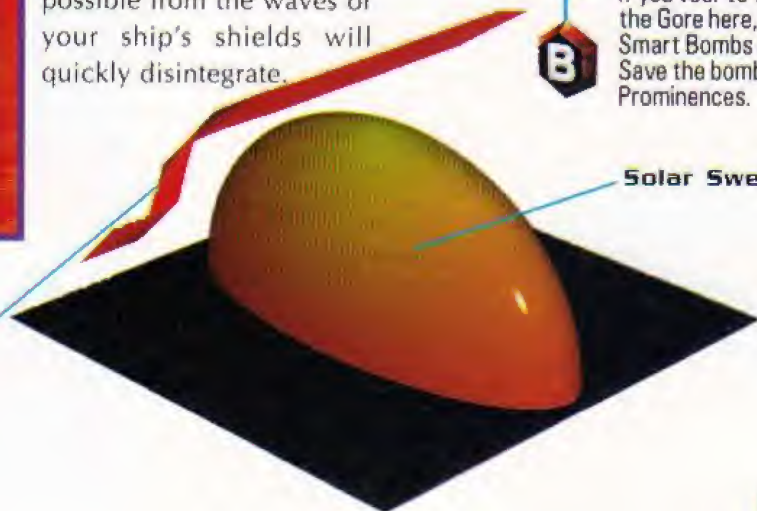

Solar Swell

MAYDAY



Falco is being chased by a Gore, and you don't have a lot of time to save him. As Falco dives for the deck to avoid the winged beast, Solar's bubbling gases will quickly devour his shield energy. Make your shot count. Hold your A Button to lock on the gruesome Gore, then blast it into the molten surface.



If you nail this Gore as it chases Slippy, you'll collect another Smart Bomb.

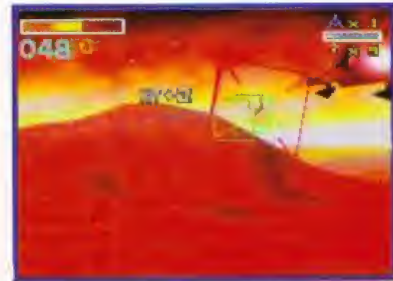

Shoot the Gore here to pick up a Smart Bomb or blast the lava bombs and load up on Supply Rings.



FROM PG. 73

01:30

01:45

02:00

02:15

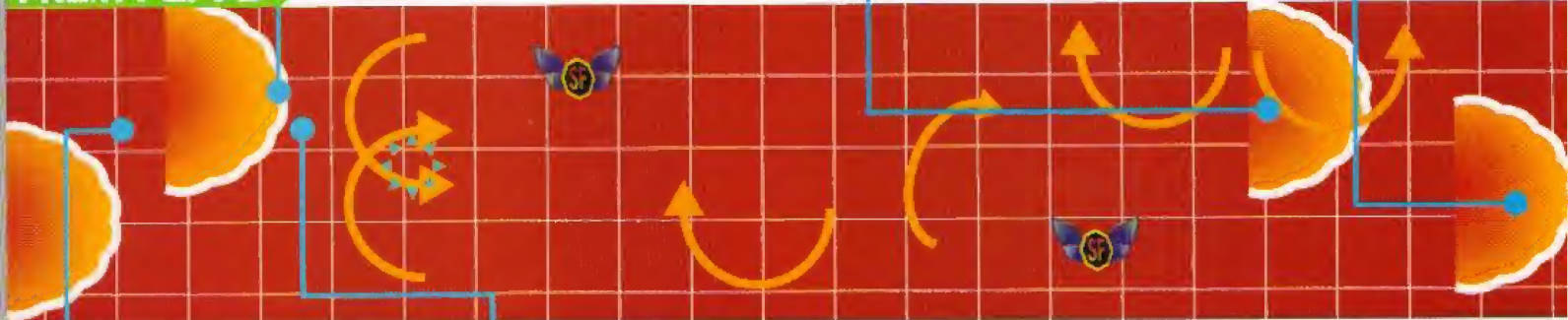

If you keep blasting away at the Gores, you'll collect five Smart Bombs here.

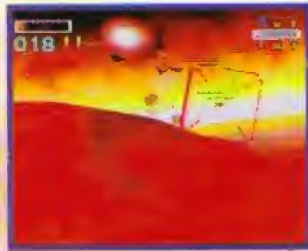

Blast the brown lava bombs and collect Smart Bombs. The flashing red rocks are holding Shield Rings.



MAYDAY



Shortly after Falco is attacked, a Gore will chase Slippy's Arwing. If you didn't lock on Falco's foe, you're going to have to make a split decision: do you save Falco or Slippy? If the Gore doesn't get them, the heat from Solar's searing surface will. Lock on the Gore or use a Smart Bomb and blow it away.





ONE COOL HOT SPOT

LYLAT DATALINK With a surface temperature in excess of 3,500 degrees Kelvin, Solar is the undisputed hot spot in the Lylat System. When measured against other stars in the system, however, Solar looks downright frigid. Solar is a red M-Class dwarf, one of the coldest stars in the universe. In contrast, Solar's antithesis, a B-Class Blue star, has a searing surface temperature of 25,000 degrees Kelvin and a life expectancy of a couple billion years. Luckily, M-Class stars burn the slowest and last the longest. Scientists predict that Solar will keep shining in the Lylat System for 100 billion years or more.

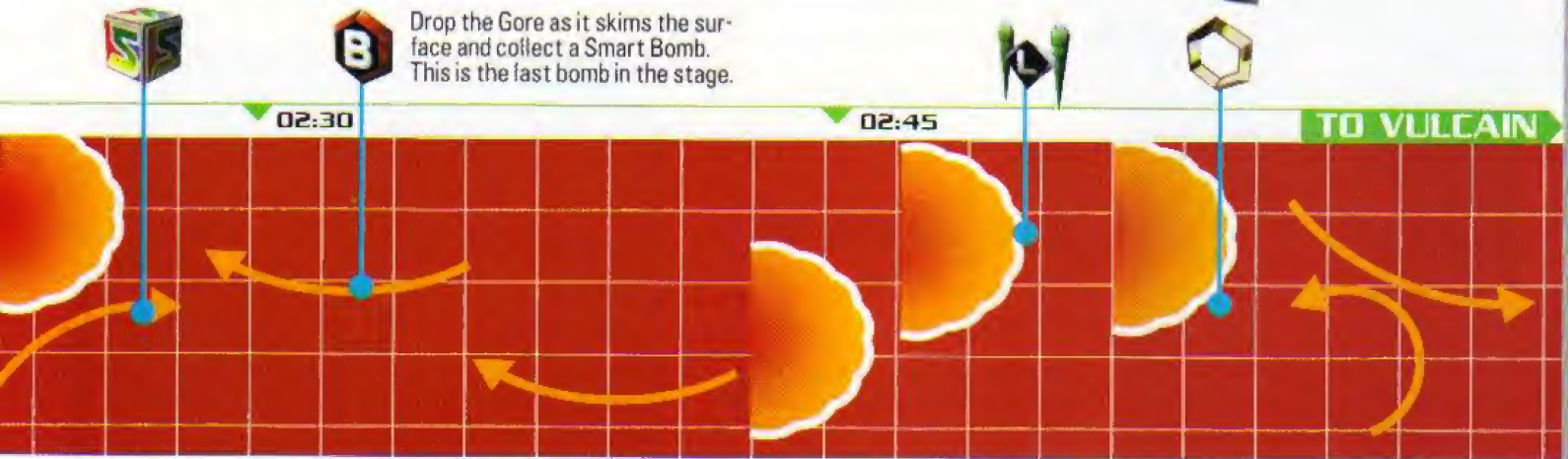

VULCAIN

Vulcain is one of the most advanced bioweapons in the Lylat System. Besides being able to adapt to Solar's extreme temperatures, Vulcain can modify its genetic structure by absorbing and altering the molecules of the objects in its environment. If you're not careful, you'll end up out of Solar's frying pan and into Vulcain's fire.



After you destroy Vulcain's pointed limbs, target his mouth and blast away with your Arwing lasers.



Arms

Target Vulcain's sharp limbs before he splashes a massive plasma wave at you. Later in the battle, he'll regenerate new, mutated arms.

Mouth

Vulcain spews rocks at you, but this isn't a bad thing. As you destroy the rocks, they'll transform into Supply Rings. Collect the rings and continue the battle.

Vulcain will submerge part way through the battle and make waves. Tilt on your side to avoid the tidal wave.



Mission 10

150 hits

MACBETH

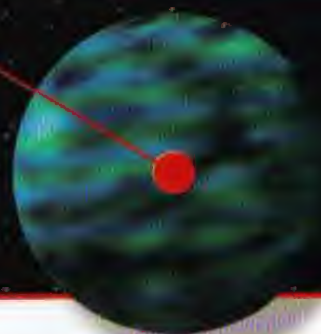

Macbeth is the industrial key to Andross's military machine. If you liberate this planet, Fox, you will cripple his ability to produce weaponry. This is also the main launching point for the interplanetary cruise missiles Andross has been using to assault Corneria. Resistance fighters on Macbeth have information on a train that transports minerals and weapons from the mines and factories to Andross's main base and launching area. Although its route is well defended, derailing the train and stopping its shipment will be a crippling blow to Andross's plans.

1 TO BOLSE CHALLENGE

▶▶▶

The Venom force at Bolse is weaker than the group at Area 6, but it's still one of the toughest stages in the game. You'll have to defeat Mechbeth with your normal weapons to reach Bolse.

2 TO AREA 6 CHALLENGE

▶▶▶▶

You must flip eight railroad switches and force Macbeth's supply train off the tracks if you want to reach Area 6. Listen to Peppy if you want to learn how to derail this crazy train.



VENOM'S SUPPLY DEPOT

Planet Macbeth serves as the supply depot for the Venom forces in the Lylat system. The base is also used for manufacturing many of Andross's conventional weapons, including the massive ship-to-ship missiles deployed in Area 6. As General Pepper mentioned in his briefing, attacking Macbeth is a brilliant

strategy for weakening the remaining enemy forces around Corneria, but it won't be easy. In order to take out the supply train and the base defense units, you'll have to conduct a ground assault with the Landmaster. The remainder of your Star Fox team will fly overhead and provide air support.



Planetary Data

● Radius.....	7,954 skm
● Albedo.....	0.25
● Gravity.....	1.270
● Esc. Velocity.....	15.31 skm/s
● Equilibrium K.....	230
● Atmosphere.....	N275.0220
● Hydrographics.....	68%
● Biomass.....	539 Quads
● Class.....	M

Planetary Compendium

Macbeth is well known as a mineral treasure house. The planet has a relatively large population of miners, who have recently been enslaved by Andross to manufacture weapons and supplies for his armies.

**ENEMY RECON****The Weapons Factory**

Much of Macbeth's Birnam Wood was cleared away to make room for Venom's Army Supply Base. The colossal Weapons Factory here assembles the missile components used against the Corneria forces fighting in Sector Z. You don't have the firepower to destroy this hardened target, but if you redirect one of the weapons trains, you might set off a devastating chain reaction.

**The Liquid Fuel Carrier**

The Liquid Fuel Carrier is one of several cars you'll have to destroy before taking on Mechbeth. When you ignite the volatile cargo on the carrier, the subsequent explosion will demolish the nearby cars, making it easier for you to attack the cars near the front of the train, but you'll take damage if you're close to the car when it explodes.

**Cannon Car**

The Cannon Car is a standard security car attached to all supply trains on Macbeth. This defense unit is armed with a bomb and a missile weapons system reinforced with heavy armor plating. If you fire enough shots you'll destroy it, but you'll earn more points if you spend your time blasting the smaller targets on both sides of the track.

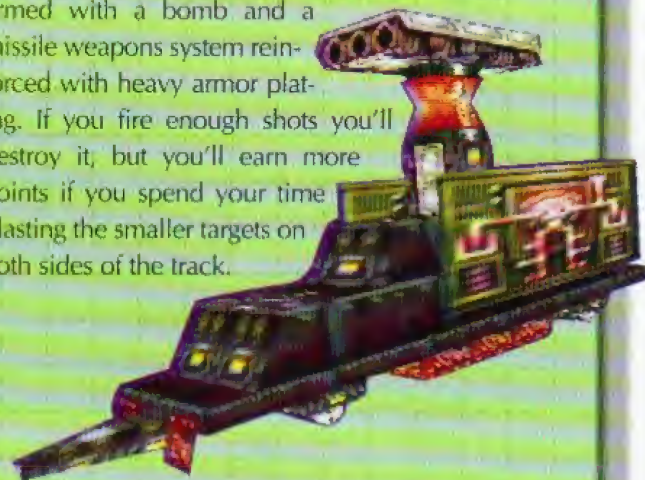
**Tripods**

You've already encountered Tripods on other missions, but you'll find larger numbers of the flying foes on Macbeth. That's because Tripods are manufactured here. These newest versions are equipped with Andross's latest aerial combat computers. Shoot them down before they lock on your Arwing.

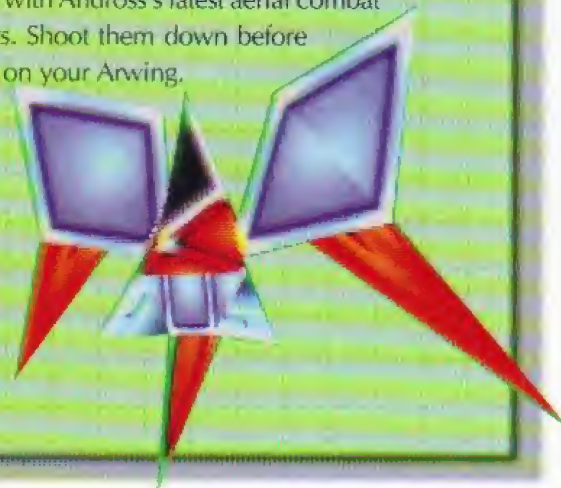

1

ROCK OR GET ROCKED

Crank up the hits on the heavy ore cars carrying the large boulders as soon as you begin the mission. You'll add seven points to your score each time you destroy a loaded ore car, and you won't have to worry about obstacles in your path. The trick is to remain on the left side of the screen, close to the train, and concentrate all of your firepower on one target at a time. Ignore most of the other targets shooting at you. Fire as fast as possible or the car will dump the boulders in your path and you'll have to redirect your fire at the obstacles or take heavy damage.



START

00:15

00:30

00:45

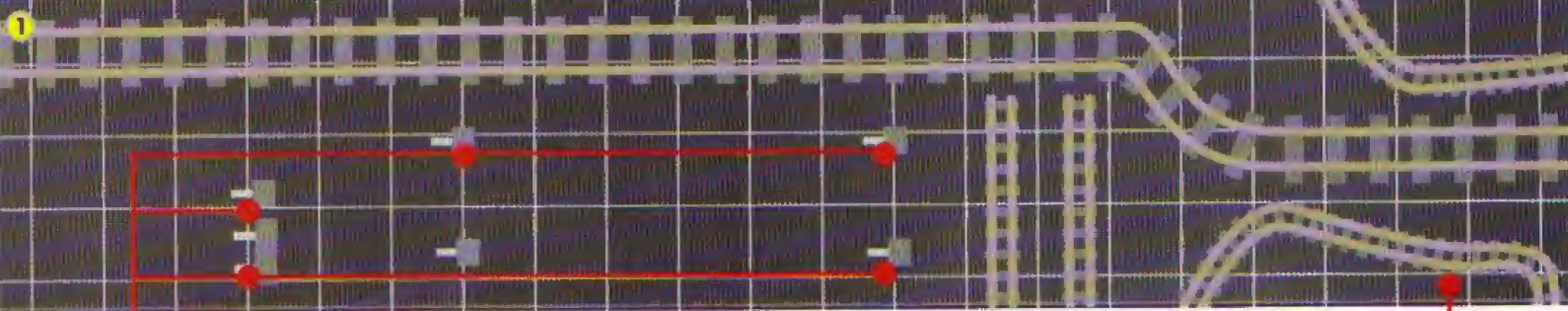

B

Destroy the defense towers to find bombs at random. You may find five or none!



An automated gun is guarding this railway spur. Knock it out to collect a Shield Ring.



The bombs will be floating up in the air. Use the tank's thrusters (press and hold Z and R) to fly up and retrieve them.



LOCK ON

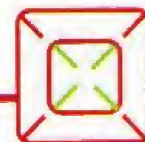

LOCK ON FAST FIGHTERS

Clouds of Tripod and Dragon Fighters cover this section of the track. Tripods fly low and slow, so it's easy to knock them out with a single shot, but the Dragon Fighters are fast and tough to follow. Lock on the Dragon Fighters and let your Landmaster's tracking system go to work. While it's tempting to completely clear the skies with several Smart Bombs, save them for the large clusters of enemies. Destroying fighter groups with a single bomb will quickly boost your overall score.

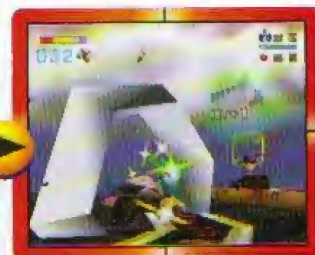



LOCK ON

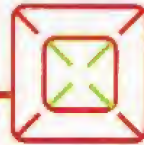

DODGE THE ROLLING ROCKS

If you can't take out all the ore cars, the train will slow down and the ore cars will roll boulders into the path of your Landmaster. After being dumped, these rocks will spin and start rolling straight toward you. Lock on the boulders with your main cannon and blast away. Steer between the gaps in the rocks and resume chasing the train.



Down the squadron of Dragon Fighters here to earn an additional Smart Bomb.

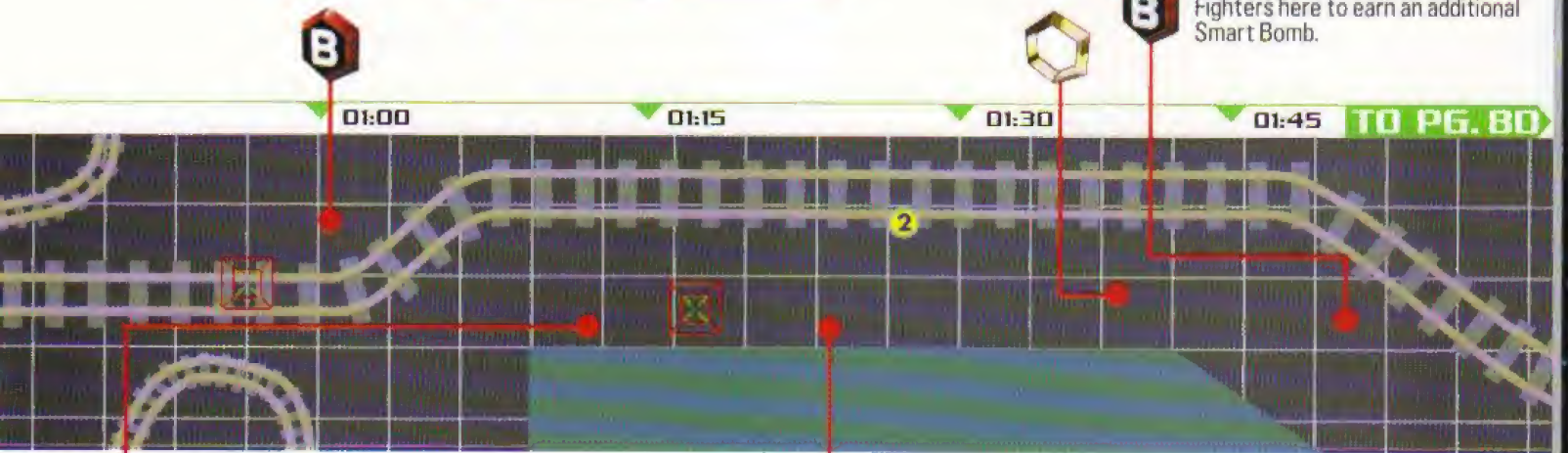

Break up the swarm of five Tripods and hover up to the Shield Ring floating here.



Another Shield Ring will appear here after you clear two waves of rolling rocks.



2

CANNON CAR CARNAGE

The train rises on an elevated track, giving the Cannon Car an unobstructed view of everything around your Landmaster. Since it's easy for you to dodge the cannonballs with a barrel roll, the Cannon Car will shoot at the boulders above the canyon wall, causing them to rain down on you. Don't waste your time trading shots with the Cannon Car; instead, increase your score by blasting the rocks in the canyon. You'll get even later in the stage.



1 HOVER AND HURDLE



As you chase the train down the tracks, the crooked engineer will activate security barriers behind the train. Hold your Z and R Buttons to activate the Landmaster's thrusters and hover up and over each barrier. Like your booster, the thrusters have limited power, so don't hover too soon or your Landmaster will trip and go sprawling between the railroad ties. Don't tailgate the railroad cars or you won't have enough time to react to the protruding barriers. If you still end up getting tripped up, note and remember the locations of the four barriers shown on the map below.

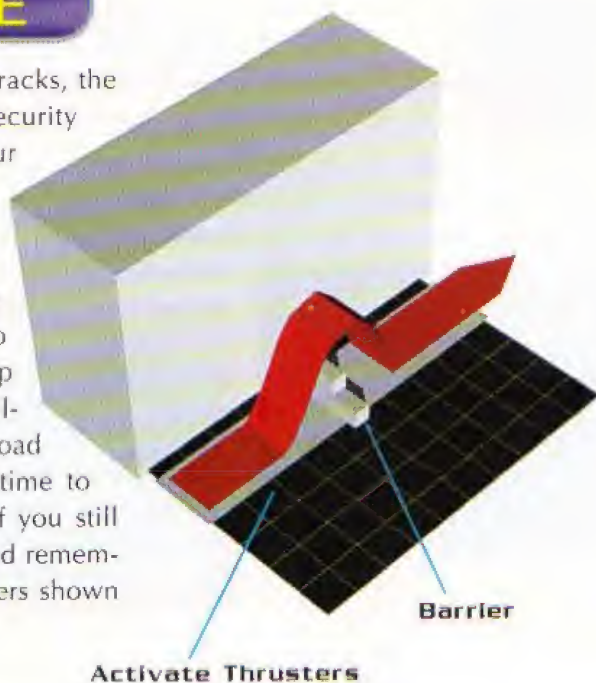

FROM PG. 79

02:15

02:30

02:45

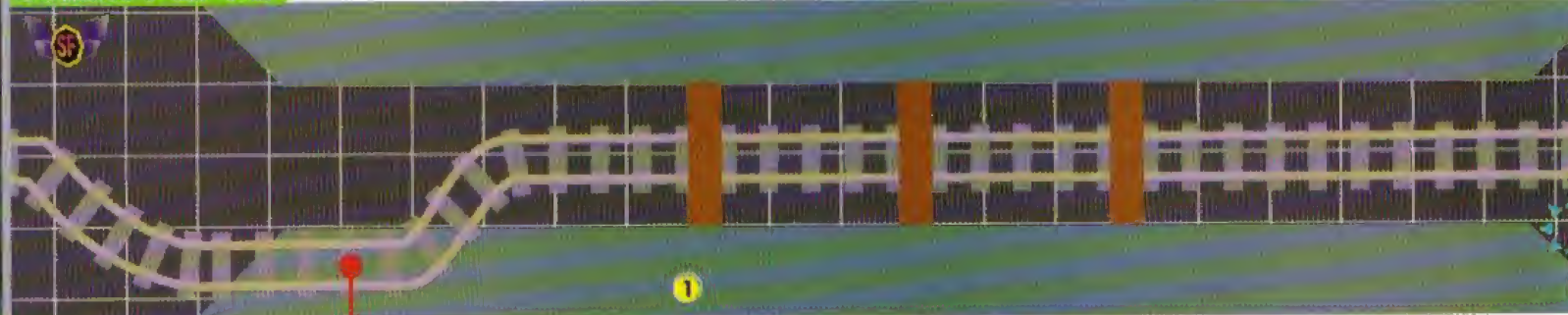

2 DODGE THE DOORS

Supply Rings, Shield Rings and Smart Bombs are waiting for you behind heavy steel doors on both sides of the track. You can't use your Landmaster's laser or Smart Bombs like you did on the gates on Corneria. To control the mechanisms that open and close the doors on Macbeth. Use your Landmaster's booster or brakes and time your approach so you can roll through the industrial strength barriers without being shut out or beaten up.



MAYDAY

 Falco has bitten off more than he can chew with a swarm of enemy fighters. Now he has a foe locked on his tail feathers.



3

FLIP THE SWITCHES!

The easiest way to defeat Mechbeth is to derail the train and send it careening into a weapons factory. Andross anticipated this plan and designed an elaborate safeguard system to deter sabotage. Luckily, Peppy has figured out a way to derail the train. You'll have to flip eight switches and blast the track control. Use either the Landmaster's cannon or Smart Bombs to spin the numbered switches. If you can detonate a bomb directly between Switches Three and Four, you'll flip them simultaneously. The first five switch locations are designated on the right half of the map below.



03:00

03:15

03:30

03:45

TO PG. 82

LYLAT
DATALINKTHE TRAGIC TALE
OF MACBETH

Years ago Macbeth was the center of the aerospace industry for the Lylat System. Gifted scientists and engineers flocked to the planet to share knowledge and make staggering sums of money. Orders poured in and a consortium of companies worked long hours to meet the demand. While there should have been enough wealth for everyone, a handful of greedy CEOs tried to gather up all the power by betraying the consortium with hostile takeovers and leveraged buyouts. Capitalizing on the confusion and brutal infighting, Andross invaded the planet, enslaved the scientists and set up weapon assembly lines.



4 THE FINAL THREE SWITCHES



The final three switches are hard to hit, especially since Switch 7 and Switch 8 are on opposite sides of the track and Mechbeth will try to distract you. You can flip the last two switches simultaneously by detonating a Smart Bomb in the middle of the track. This is the most difficult part of your mission. If you pull it off, you'll still have to destroy the track control box. Follow



the tips for finding it in the box directly below.

FROM PG. 81

04:30

04:45

05:00

TO MECHBETH

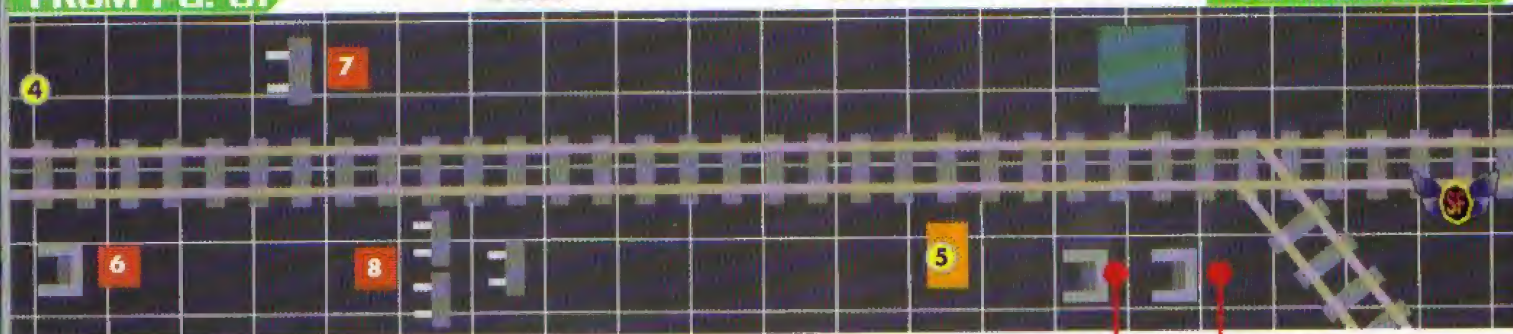

5 CHANGE COURSE

The eight switches that you flipped safeguard the control mechanisms inside the track control box. You'll be able to change the tracks if all of the eight round lights on the box are blue. A red light on the control box indicates that you missed flipping a switch and that the track cannot be changed. To change the track and force MacBeth's supply train off course, blast the control box twice with your cannon or Smart Bombs and watch the fireworks—you're off to Area 6.



MAYDAY

Peppy didn't see the enemy fighters creep up on him while he was watching you shoot the switches. It's tough to lock on the pursuing enemies while Mechbeth is blocking your shot. Try using a Smart Bomb on the fighters. As cruel as it sounds, you won't have to save Peppy if you've already flipped the track switches.

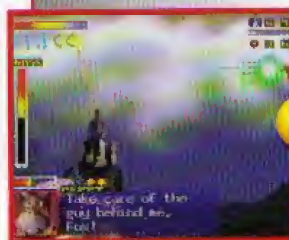

MECHBETH

Mechbeth's internal power generator is still in the development stages, so the bioweapon remains tethered to an energy supply canister onboard the train. Its advanced combat computer, however, is fully functional and armed with a trio of the deadliest attack weapons ever designed on the planet.

Head

Mechbeth shoots nearly a dozen explosive iron bars from its head in one shot. To avoid damage, you must destroy the metal bars that land directly in front of you.

Wings

If Mechbeth has enough time, it will gather energy into its wings and shoot a pair of powerful blue beams at you. Stay between the moving beams to avoid damage.



Mechbeth's head has an endless supply of explosive iron bars. Lock on the bars obstructing your path and blow them away, then continue shooting the head.



Tail

If you're not careful, Mechbeth will sweep down, spear you with its tail, then drop you. Execute a barrel roll and spin to safety when Mechbeth starts to dive.



After you've destroyed the head and arms, target the control panel on the train's energy supply container. If you wait long enough, the control panel will open.



Slam the exposed control panel with a powered-up laser blast, then use quick bursts to finish the attack. Mechbeth can't react as long as you're hitting the panel.

DETOUR OF DUTY

GET ON TRACK

Your next destination depends on whether you blast the eight switches and change the train tracks or end up blasting Mechbeth into scrap metal with your Landmaster's weapons.

THE RIGHT TRACK

If you manage to flip all eight switches and hit the control box, Mechbeth will roll down the wrong track and demolish the weapons factory. Andross is scrambling to assemble a last ditch defense force to intercept you at Area 6.

MECHBETH IS DISCONNECTED

If you use your lasers and Smart Bombs to disconnect Mechbeth, the Star Fox team will be redirected to the Venom forces at Bolse. Don't think that this is the easy way out—your trouble is just beginning.



TO AREA 6 PG. 100



TO BOLSE PG. 56

Mission 11

150 hits

AQUAS

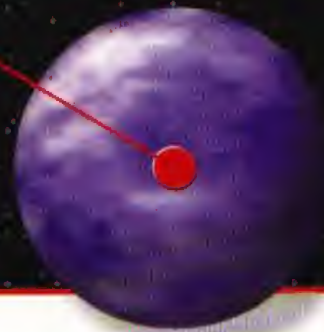

Fox, we have received reports

that Andross is using bioengineering techniques to mutate the sea creatures of Aquas into deadly bioweapons. However, because of the rapidly spreading pollution in the planet's ocean, we have been unable to determine exactly what is going on there. We need to have you take the plunge and get to the bottom of Andross's schemes on Aquas. I understand that Slippy has designed an experimental battle submersible, the Blue-Marine, that can do the job. You're our only chance on this one, Fox!

TO ZONESS CHALLENGE



Once you plunge into the murky waters of Aquas, you have only one route to follow. If you survive the ordeal in the deep, you'll move on to Zoness in your next mission.



ASSAULT ON AQUAS

Aboard the Blue-Marine attack sub, you must navigate through deep channels filled with biological terrors. You'll find few rings or upgrades here and precious little help from your comrades. Unlike in some areas, in Aquas you shouldn't expect to destroy every enemy you see. Some of the creatures,

such as the exploding Starfish, should be avoided. The Blue-Marine operates a bit differently from an Arwing, particularly with regard to locking on with your torpedoes. Since you have no limit to the number of torps, use them constantly. Some enemies will be damaged only by torpedo blasts.



Planetary Data

- Radius.....5,789 skm
- Albedo.....0.45
- Gravity.....0.873
- Esc Velocity.....11.23 skm/s
- Equilibrium K.....280
- Atmosphere.....N276.0223
- Hydrographics.....97%
- Biomass.....2,545 Quads
- Class.....W

Planetary Compendium

The entire surface of Aquas is covered with water. Normally the ocean teems with life but the predations of Andross's forces have done severe damage to the planet's ecosystem. Undersea ruins indicate that Aquas was once inhabited by intelligent beings.



ENEMY RECON

Giant Spindly Fish

These lurking lunkers appear about a third of the way through the ocean stage. You can destroy them with lasers or torpedoes, but use torps quickly in order to get the maximum three hits. The fish swim across your path, from right to left, not allowing you much time.



Angler Fish

The dreaded Angler Fish light up the abyss with their powerful, glowing appendages. They are tough as nails, and you'll have to nail them with multiple torpedo shots to black them out.

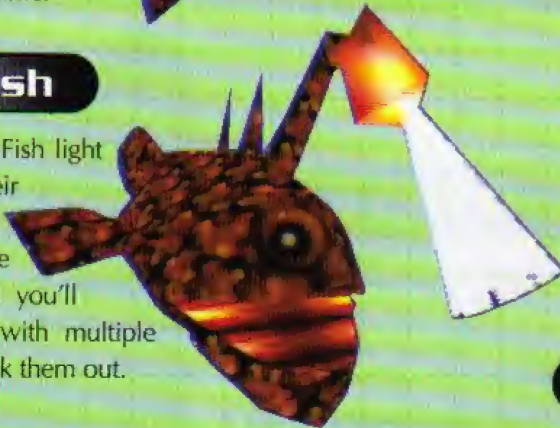

Garoas

The mysterious Garoas hide within their shells until disturbed by torpedo shots from the Blue-Marine, then they spread their wings wide in a dangerous embrace. When the wings are spread, fire a torp and follow it up with laser shots.



Starfish

These Starfish explode when hit by torpedoes or when in close proximity to the Blue-Marine. Shoot them at a distance so they explode before you get too close. A good alternative is to avoid them.



Aquas Squid

The giant squid can be found in several locations of the ocean, but they never present much of a problem. A single torpedo will turn them into Calamari, and you can destroy several with a single shot.

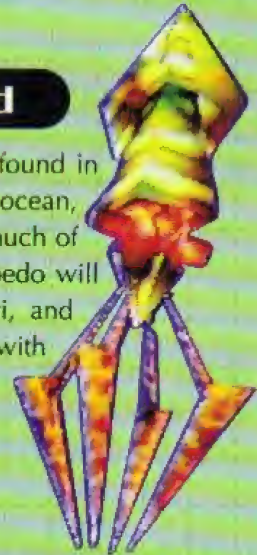

Sculpins

Schools of Sculpins lie on the seabed waiting your approach. If you don't stir them up, they'll launch up and hit you. Start blasting them with your laser and torpedoes at a distance to score mass hits.

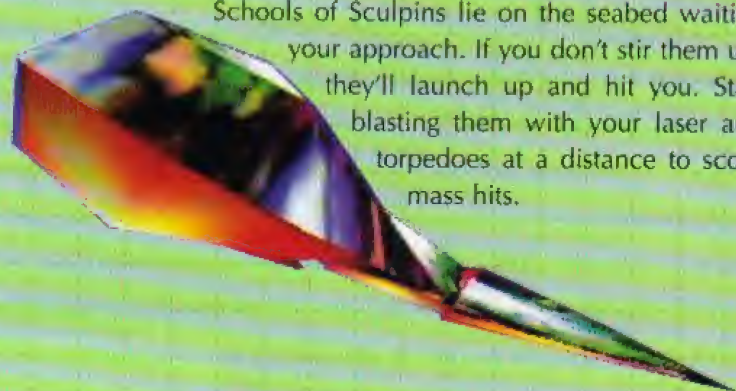

1 DON'T CLAM UP

Clams on Aquas sometimes contain pearls such as Supply Rings, Shield Rings and Laser Upgrades. When you begin your aquatic mission, the first clam to the right has a Shield Ring and the third clam, beyond the first arch, has a Supply Ring.



Just beyond the small mound is a clam containing a gold ring. Target the shell with a torpedo to open up the clam.



Pass through all three stone arches and then defeat the clam here to make a Laser Upgrade appear.

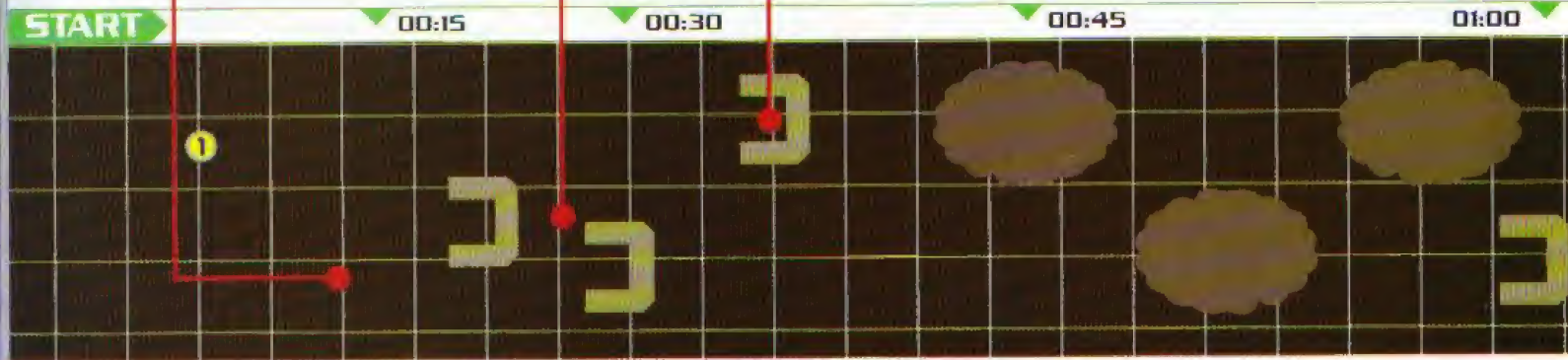

2 GUNNING FOR GAROAS

After passing through the third arch, a pair of Garoas appear with their wings folded around them. Open fire with torpedoes to get the Garoas to spread their wings. Once the wings are open, you can use either torpedoes or lasers to win the battle. You'll earn a Supply Ring from one of the defeated enemies.

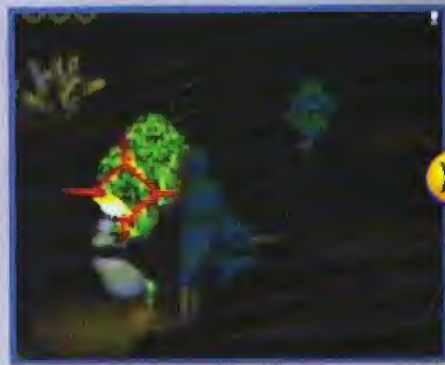

MYSTERIES IN THE DEEP

The ancient civilization of Aquas once stood above the waves on a series of islands amidst the global ocean. There, people built great temples and made a living by harvesting sea life from the surrounding waters. But long ago, a monstrous entity known as Bacoon grew in the depths of the ocean, and it was jealous of the glorious civilization on the land. Over many years, Bacoon grew powerful. It learned to control the other aquatic lifeforms, like the explosive Starfish. When Bacoon commanded thousands of the Starfish to migrate to the ice cap and explode, the resulting heat melted the polar cap and all the islands were covered by the sea forever.

3 GIANT SPINDLY FISH

These long fish appear swimming slowly out of the blackness and cross your path. You won't have long to destroy them, so shoot torpedoes and lasers. Lock on your torps—you may get a Supply Ring from the first fish.



Defeat the first Angler Fish using four or five torpedoes to get up to three hits and a Shield Ring.

Blast the second damaged column in the second ruins to find a Shield Ring.

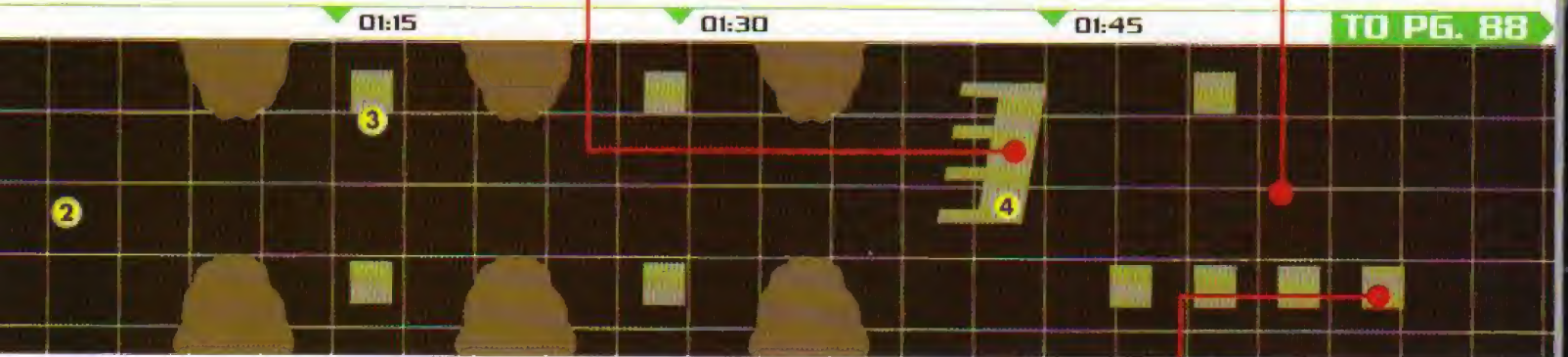

4 TREASURE IN THE RUINS

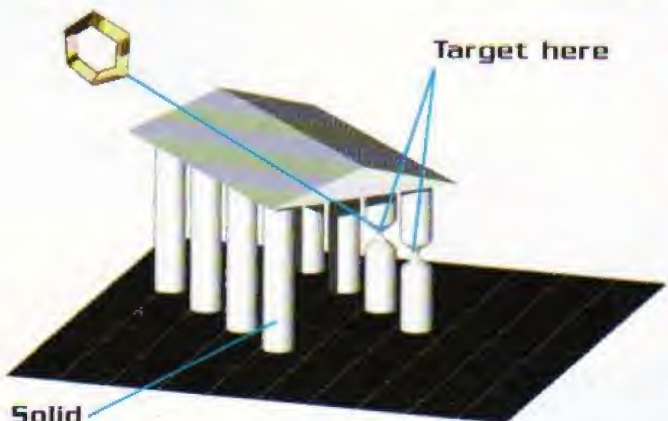

The sunken temple columns may contain valuable items for the Blue-Marine. Only columns that show cracks in the middle can be broken. The second column in the second row of columns contains a gold ring. Lock on your torpedoes to blast them quickly.



In the final damaged column of the third ruins, you can pick up a Supply Ring.

1 SPIN AND WIN



When the under-sea bioenemies fire at the Blue Marine, spin to avoid being hit. This only works to defend against shots. Explosions from Starfish and hits from rocks will still damage the sub when you're spinning.

2 ANGRY ANGLER

Shortly after the Checkpoint, an Angler fish will appear from the left side of the trench. Hit it quickly and repeatedly with torpedo shots. The big fish turns red when you make a direct hit. Two torpedo shots and several laser blasts will finish it off and leave you with a silver Supply Ring as a reward. A second Angler will leave a shield ring.



FROM PG. 87

02:30

02:45

03:00

03:15



2



Just to the right of the first bed of Sculpins beyond the Checkpoint, you'll find a clam shell with a Laser Upgrade inside.



4



About half of the way through the deep trench, you'll find a lone clam shell with a Laser Upgrade inside.

3 JELLY ANGLER



Tripods of jellyfish in the trench present a unified front. It's best to avoid their potent lightning charges and slip quietly past. You can't lock on these enemies and you have more important things to worry about, like the exploding Starfish.



4 DEPTH CHARGES

The first problem in the trench region comes from exploding Starfish. You can blast them at a distance to detonate them before you come within range, or you can dodge their explosions using brakes and boosters. The second threat is at the end of the trench, where boulders rain down from above. Stay high to miss most of them, then veer downward to take out the Garoa.



Use torpedoes and laser shots to sink the Garoa found here and win a Supply Ring.

03:30

03:45

TO BACCOON

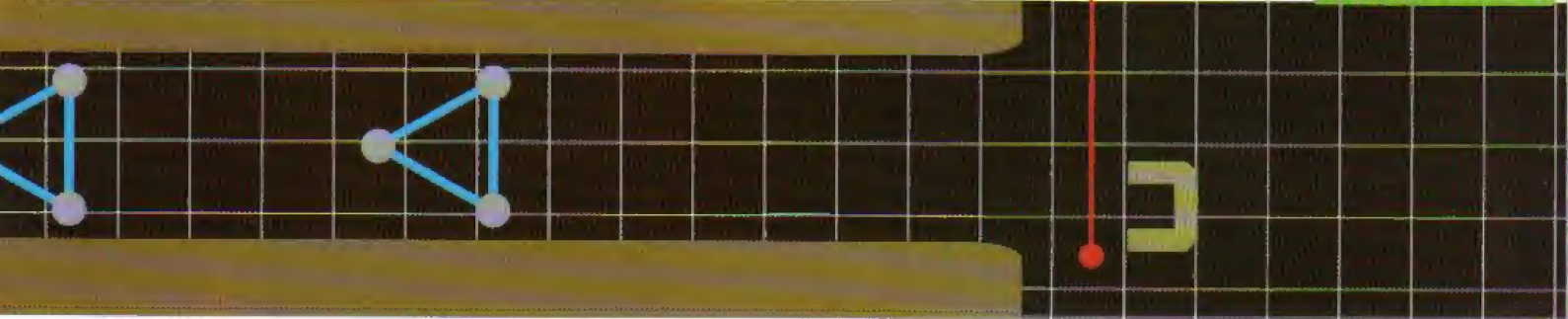

BACCOON

This giant, evil clam-like being looks worse than it really is. Begin by shooting the two muscles on either side of the eye. When the top comes off, shoot the eye until you win.

Worms The snake-like worms that wriggle out of the pods on top of the clam shell will attack the Blue-Marine ceaselessly unless you blast them. You can destroy the pods to end this threat.

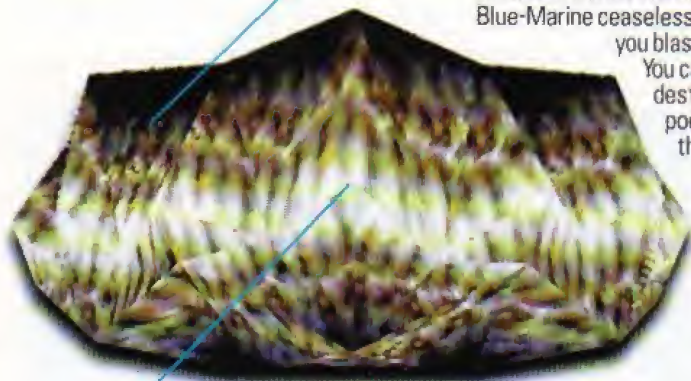

Mouth Inside Baccoon's gaping mouth, you'll see two red muscles that hold the two halves of the shell together. Blast the muscles using lasers and torps until they break. Then shoot the eye.

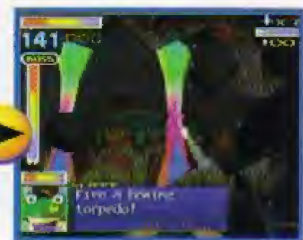

Begin your attack by shooting the muscles and destroying the worms when they close in.



When the muscles are gone, the top half of the shell will be destroyed, and the eye will appear.

Continue to shoot the eye and the pearls that fly at you. It's just a matter of time before you bake this clam.



Mission 12

250 hits

ZONESS

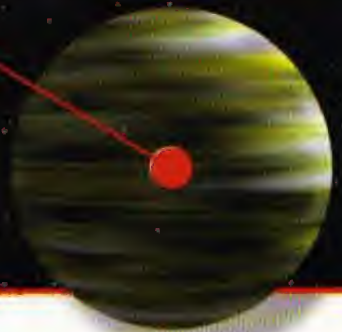

What a place to battle! Andross has turned Zoness into a toxic waste dump and is rumored to be building a supply base there! Fox, see what kind of trouble he is brewing up there. Watch out for mutated native life-forms—they're tough! Andross's refinery installations have security systems with high powered searchlights to scan through Zoness's tainted atmosphere. Don't let the searchlights spot you or you'll lose the element of surprise.

1 TO MACBETH CHALLENGE

▶▶▶▶▶

If Andross's forces detect you, you'll have to divert your attack to a different front. Macbeth, Andross's main supply depot, would be the perfect place to deal him a crippling blow and turn the tide of the war.

2 TO SECTOR Z CHALLENGE

▶▶▶▶▶

If you can pass Zoness without being detected, you'll then rendezvous with ROB 64 and Great Fox in Sector Z. You should be able to take cover there among all the space junk.

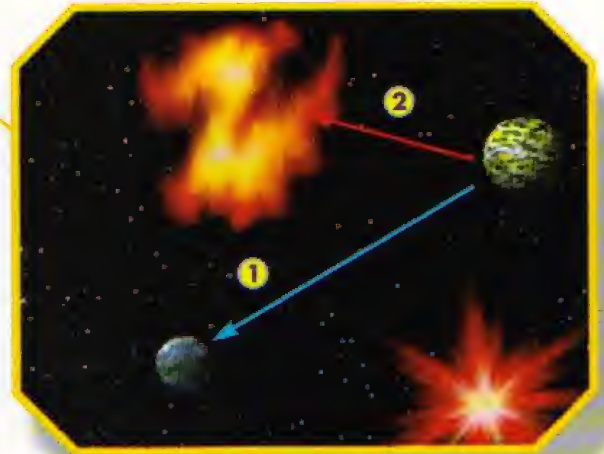

TOXIC TERROR

Though you don't want to be detected by the enemy's radar network, you definitely want to make your presence known here on Zoness. Not only do you have the chance to cripple Andross's supply lines, but you can also stock up on much needed items and weapons, especially Smart Bombs. The enemy fleet is

counting on the mutated marine life to provide the first line of defense for the cargo ships, but there are many more Androssian patrols closer to the convoy. The cargo ships are protected against your weapons, but the cargo containers are not. Blast them open to reveal a slew of rings and bombs.



Planetary Data

- Radius.....3,354 skm
- Albedo.....17
- Gravity.....56
- Esc. Velocity.....7.23 skm/s
- Equilibrium K.....283
- Atmosphere.....N250-CO221-OH422
- Hydrographics...90%
- Biomass.....1,670 Quads
- Class.....T

Planet Compendium

Zoness was once the aquatic vacation world of the Lylat system. The planet is nearly covered with ocean, with only small groups of islands breaking the watery surface. However, Andross's bioweapon has polluted the once beautiful oceans and transformed the beautiful sea creatures into hideous monstrosities.



ENEMY RECON

Radar Buoys

These seemingly harmless searchlights actually house powerful radar systems. They start off in a "passive" search mode, scanning only if an unidentified craft approaches. If you pass one without destroying it, it will switch to "aggressor" mode and activate the rest of the radar network.



Troikas

Grown to thousands of times their normal size, these genetically enhanced fish will leap out of the sea and fire spiraling blasts of energy. Charged lasers or bombs will be your best bet.

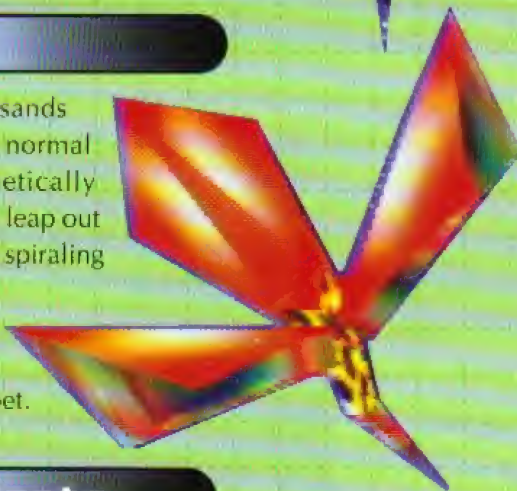

Patrol Boats

Androssian patrol boats may not be very high-tech, but they're quick and heavily armed. They travel in groups of three or more and coordinate their attacks precisely. They usually approach from behind, so keep an eye on your six!



Z-Gulls

The graceful Z-Gulls have been horribly transformed and trained to carry powerful energy bombs. Try to destroy them before they have a chance to drop their payloads. They're nearly invulnerable to normal laser fire, and it will take three or more charged laser bolts or a bomb to bring one down.

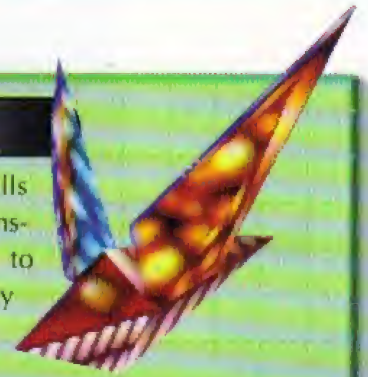

Z-Serpents

The Z-Serpents have not become as aggressive as Andross had hoped they would, making them a failure in his eyes. Although they'll ignore you for the most part, they have an annoying habit of slamming into you if you get in their way.



Kani

Once a favored delicacy in Zoness restaurants, the now monstrous Kani are looking to turn you into their next meal! Charged lasers should do the trick, and they usually leave bombs behind.



1 SEARCH AND DESTROY



The success of this "stealth" mission depends on your remaining undetected by enemy radar. If you fail to destroy even one radar buoy, the enemy will pick you up for sure, and then you'll be in real trouble! If the radar network switches to aggressor mode, the searchlights will turn red. From that point on, you can bet that Andross's fleet will throw everything they have at you. It will still be possible to complete the mission and challenge the floating Sarumarine base, but you'll be forced to bypass Sector Z and take the battle to another front.



Fly between these two rocks to make an upgrade appear. Loop immediately to collect it.



B The surest way to destroy a Troika is with a bomb, and then you'll get a bomb in return.



B Charge your lasers and be ready to cook some Kani. A Smart Bomb is your reward.



This Shield Ring was probably left for an enemy craft, but it will do nicely for you.

MAYDAY



Slippy has managed to provoke an entire group of Z-Serpents, and they're in hot pursuit. Lock on to the serpent at the center of the group and let fly with a charged laser bolt to take them out all at once.



2 PASSING LANE

Another Z-Serpent has just dropped in behind the Arwing. There's no telling which way it will turn, but unless you want to get your wing ripped off in mid-air, hit the brakes and barrel roll to one side.



3 ALL FOR ONE

There are three items at the center of your flight path, stacked one on top of the other. Aim for the bomb at the bottom and pull a loop just before you hit it. If you hit it straight on, you'll collect all three items as you come around.

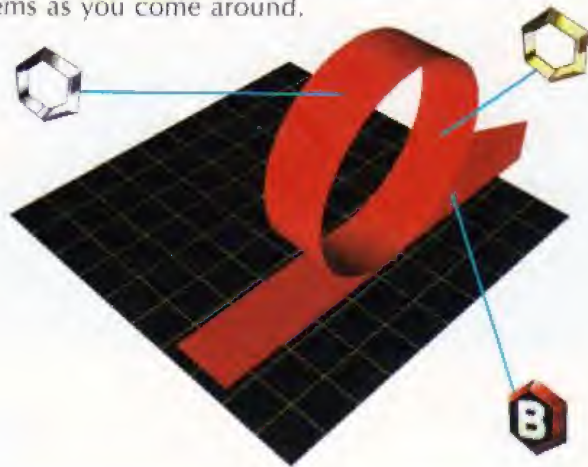

4 KATT FIGHT

Katt Monroe is not an official member of the Star Fox team, but she'll lend a blaster when it suits her. She'll take care of a few radar buoys, but don't expect her to tag them all. She's even cockier than Falco, so keep an eye on her, especially after the Todora appears. She'll probably forget to watch her six for incoming fighters. If she picks up an enemy, take it out for her.



5 TODORA

It's the migrating season for the Todora, a local species of dragon. You can't hurt them, but running into them will hurt you. ROB 64 has analyzed their movements and projected their course on to the electronic map. The arrows show which way they're going.



1 GATE CRASHER

The enemy fleet has placed a radar buoy and some items behind protective barriers. Shoot the top of the “rudders” on the sides of the gates to move them up or shoot the bottom to make them roll down. Hit the brakes to give yourself some extra time. Pull up if you don’t think they will open in time.

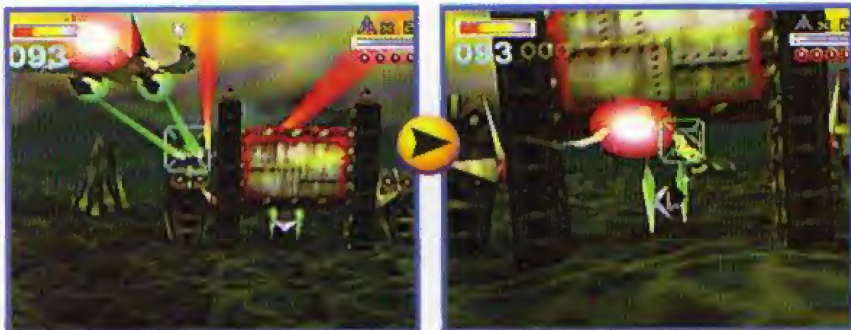

Rings and bombs are ripe for the picking! Hit the brakes and blast the crates for a huge harvest of supplies and weapons.

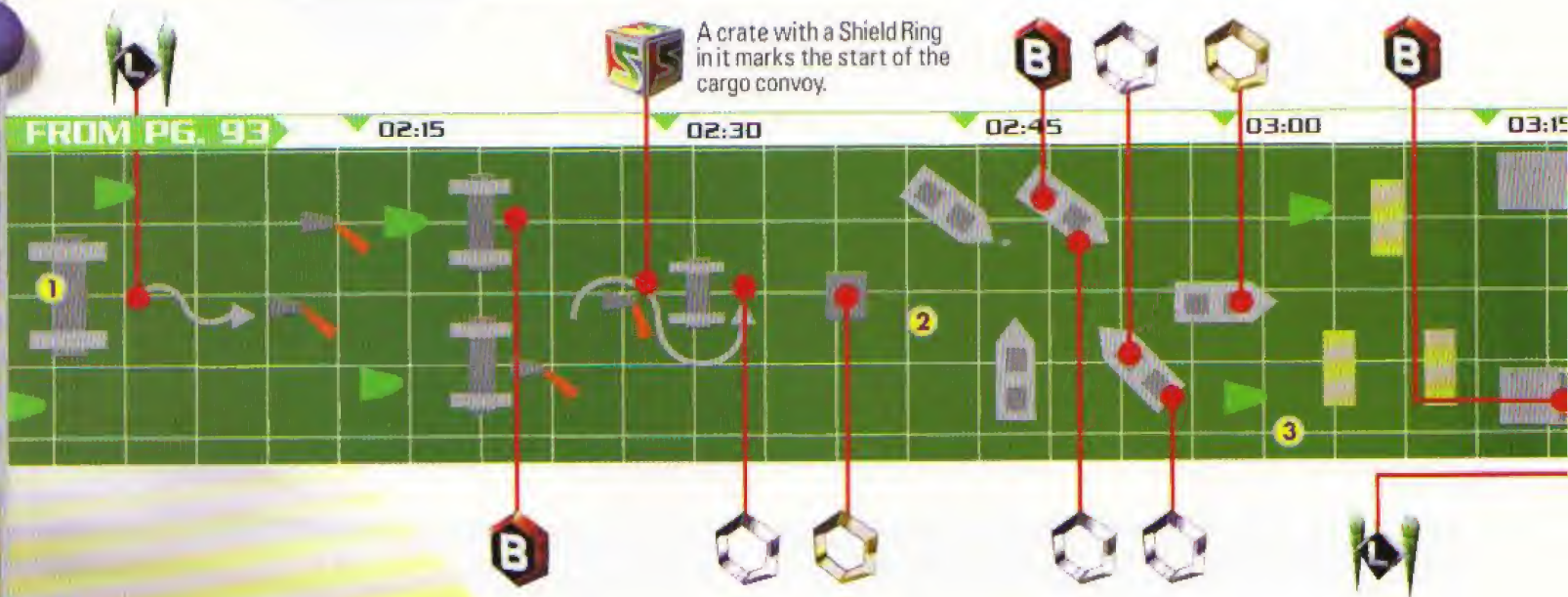

2 DUCK AND COVER

Even if you didn't set off the radar net, your enemies can't help but notice that you're invading their air space. Chances are they'll have a flight of fighters on your tail before you even reach the second cargo ship. Dive, brake and barrel-roll to avoid getting hit from behind.

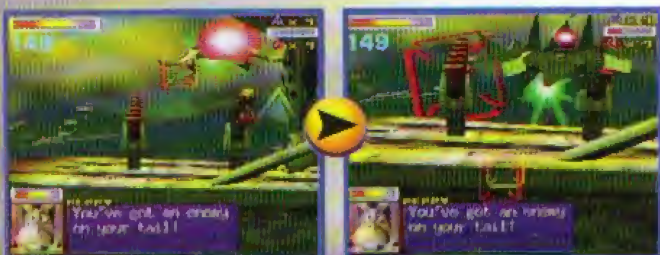

3 SLIPPY'S HUNCH

Slippy is probably just showing off—but maybe the little flipper is on to something. Follow him as he flies between the legs of the three oil rigs. If you make it through them and fly toward the gap in the platform beyond, you just might reveal a hidden, random item. It's worth a shot!



DETOUR OF DUTY

STEALTHY SORTIE

If even one radar buoy survives, the enemy will scan your ship and figure out who you are and where you're headed. If that happens, you'd better change course and take a different approach to Venom.

WE'RE OUTA HERE!

You've made it through without being detected. Great! They'll probably think this was just a surprise raid for supplies. They won't guess that you're headed to Sector Z to rendezvous with Great Fox!

WE'RE BEING SCANNED!

You've been detected! The fleet is probably signaling Andross that you're on your way, but he still won't know which way you're coming from. Set course for Macbeth.



TO SECTOR Z PG. 96



TO MACBETH PG. 76

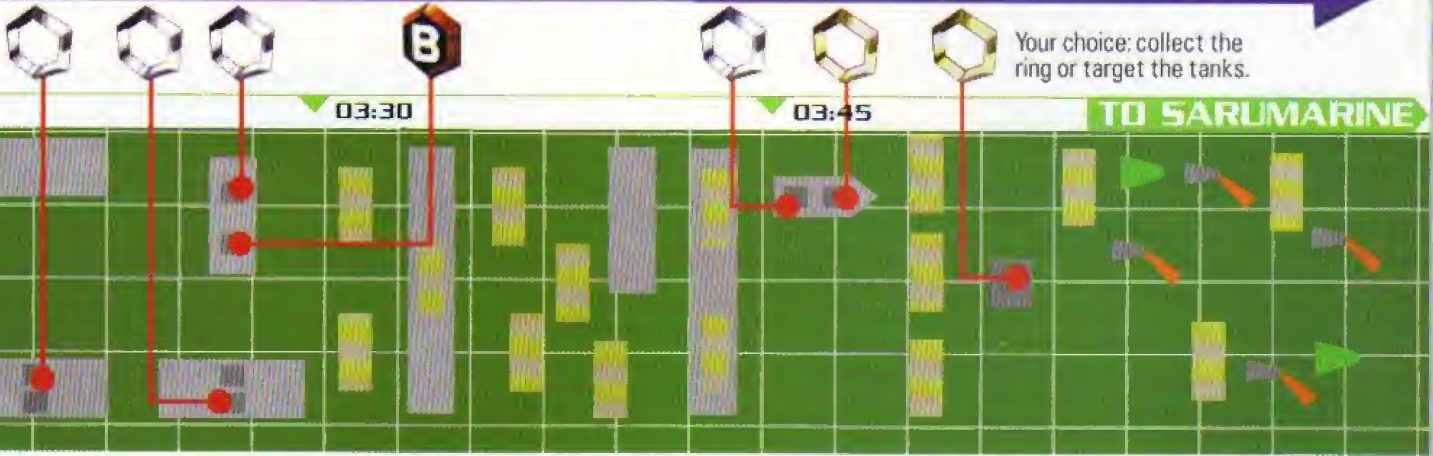

SARUMARINE

This former research station has been turned to evil purposes by Andross and is the cause of the toxic pollution of Zone55. It has the ability to repair itself by using the crane mounted on its aft deck.

Snorkel

The twin funnels act as smokestacks and snorkels. Destroy them to prevent the Sarumarine from diving.

Launcher

Destroy the globes the Sarumarine launches at you to get bombs. Grab them!

Crane

As long as the crane is operating, you won't be able to destroy the Sarumarine.

Mine

Watch out for exploding mines. Blast them for Supply Rings.



Stock up on bombs and use them on the snorkels. Once they're destroyed, bomb one of the Sarumarine's launchers.



The Sarumarine will rotate and use its crane to pull the pontoon back up. Bomb the crane.



Repeat until the crane is destroyed, then go after the rest of the base. It should take only another bomb or two.

Mission 13

100 hits

SECTOR Z



Fox, we don't know for sure what

Andross is up to in Sector Z. The nebula has become a space graveyard full of wrecked warships, so he may be scavenging them for spare parts. We're counting on your team to maneuver through the hazardous fields of space junk and scout out the situation, but be careful. Intelligence reports suggest that Andross is monitoring all space traffic in the area, and he may have a surprise for you!

1 TO BOLSE CHALLENGE

If Great Fox is heavily damaged, you'll take a less direct, but no less dangerous, route to Venom. You'll have a good chance of breaking through the Bolse station defenses on your own.

2 TO AREA 6 CHALLENGE

If you can take care of whatever evil Andross has going on here, the team can proceed through Area 6 and on to Venom. The bulk of the enemy fleet is massing in Area 6, and you'll need Great Fox to back you up.



ALL PILOTS, SCRAMBLE!

In this All-Range area, Andross's forces are piloting the improved Invader III fighter, which is faster and tougher than its predecessors. They'll try to lure you away from Great Fox and your wingmen, but stay in close so you can help them on a moment's notice. If you're having trouble tracking ene-

mies, switch to the wide-angle view. Keep targets in view as you fire your charged lasers. If you lock on to an enemy, but it flies off the screen as you fire, you may not get the hit. Once the first squadron is destroyed, another will fly in, but usually not before the first missile appears in the sector.



Sector Data

- Radiation.....4.53 ergons
- Mag Flux.....29%
- Particle Density...37 c/s
- Average Albedo...0.53
- Approx. Radius....12,530 km

Astronomic Data

An impossibly huge letter Z formed from space dust looms in Sector Z. Of the three different space dust sectors, Sector Z is the most dangerous. Not only do strange magnetic waves here make navigation difficult, but the area is also strewn with the wreckage of an epic battle from several decades earlier when Cornerian Forces defeated space pirates.

**ENEMY RECON****Copperheads**

These powerful space cruise missiles are the product of Andross's war machine on the manufacturing planet, Macbeth. You won't see them on radar until they drop out of warp, but ROB will alert you as soon as they enter sensor range. Expect them to be accompanied by flights of Invader III heavy fighters.

**Invader III**

The Invader III is the latest version of a ship first seen on Fortuna. If they give you lots of trouble, take out most but not all of the first squadron. If you destroy them all before the first missile arrives, another squadron will appear just as the missile does, making things doubly dangerous.

**Request Emergency Landing!**

Between Great Fox, the enemy fighters and all the space debris, the sky will get very crowded on this mission. Besides taking laser damage, you'll likely run into a few things, too. For a quick repair job, head toward Great Fox's rear docking bay, just above the main engine. If you

fly straight in without striking anything, you'll be repaired instantly and sent out the launch bay at the front of the ship. Your wings and shields will be fully restored, no matter how badly they were damaged, but you won't recover any lost Laser Upgrades.



SUPPLY RINGS



You won't find much in this sector, but you can get a boost to your shields from these rings. Blast open the containers to retrieve them.

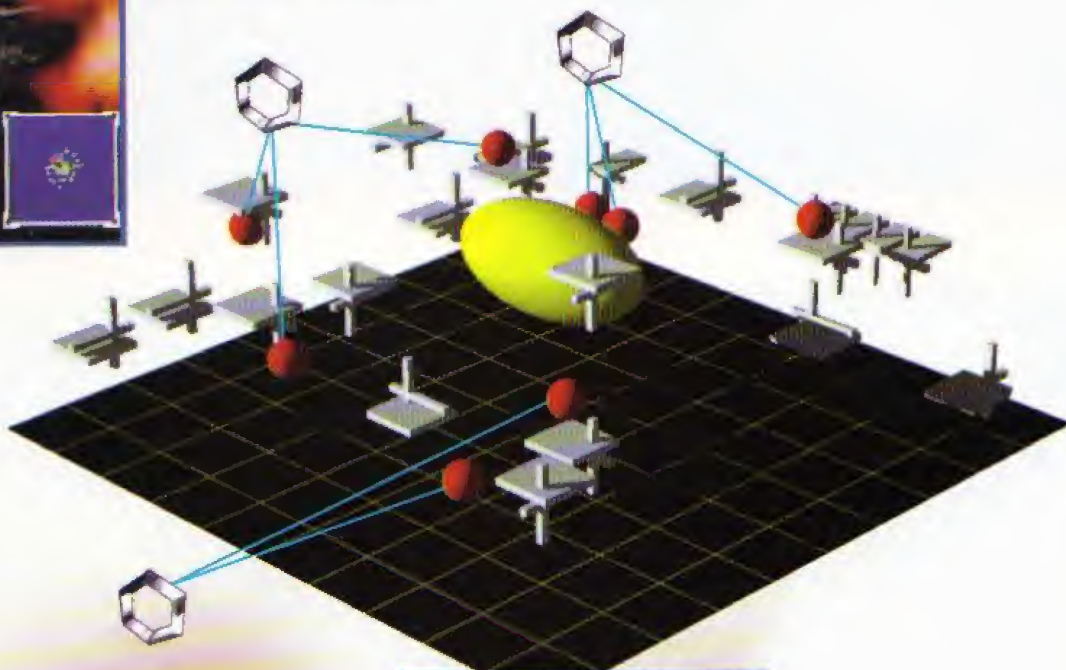

Destroying enemy ships may net you Shield Rings or Laser Upgrades, but only rarely. If you miss picking up an item on the first pass, it may disappear.

ON THE PROWL

Katt warped in just in time to help take out the third wave of missiles. It's a good thing she tracked you from Zoness. If you had come in from another direction, say, Sector X, she might not have known to come here!



KATT ON THE WING

LYLAT DATALINK

Katt Monroe is an expert pilot and an occasional ally of the Star Fox team. The Cornerian military considers her a bit of a nuisance but acknowledges that she has been useful in the fight against Andross. Intel reports state that Katt was once ambushed—and her ship crippled—by an Androssian patrol, and that because of this incident, she has dedicated herself to Andross's defeat. Katt currently flies a heavily modified Invader-class fighter, dubbed The Catspaw, apparently stolen from one of Andross's bases. When asked about this alleged incident by her close friend, Falco, Katt allegedly replied, "Just be glad I'm on your side, fly boy."

COPPERHEADS

Copperhead space cruise missiles are heavily ray-shielded, so unless you have hyper lasers, it will take several charged bolts and regular shots to bring each one down. The first missile will approach on its own, followed a minute or two later by a pair and then a triplet of missiles. ROB 64 will call out the distance between the missiles and Great Fox as they make their final approach.

Warhead

The Copperhead is designed to penetrate the outer skin of a ship, using its rotating warhead to burrow in and then explode.

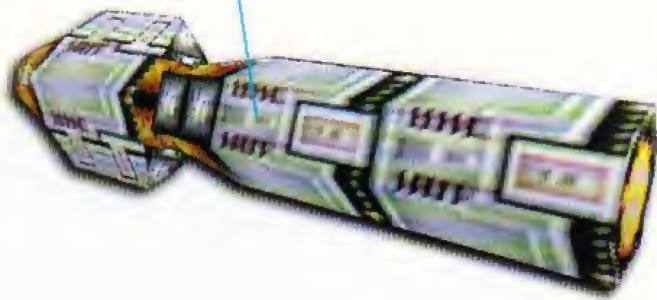

ROB 64 will alert you before the missiles appear on your radar screen. They always approach from the left side of Great Fox. When they appear on radar, head toward them. Even if they're not in range of normal shots, you can target them with charged bolts.



If you don't destroy them head on, loop around and target them from behind. Fire charged bolts immediately followed by regular shots.

DETOUR OF DUTY

INCOMING!

Your next move depends on whether or not the Great Fox can make it through this sector unscathed. If it does, you'll all head into Area 6 to face the bulk of Andross's fleet. Without Great Fox's support, you'll have to take a stealthier route to Venom.

ALL CLEAR!

With all of the missiles destroyed, you can now proceed to Area 6 and take the battle to Andross's front door. You can believe that Great Fox will make a big difference in the coming battle.

DAMAGE REPORT!

The Great Fox has been heavily damaged, and it won't be able to continue to Venom. Though the route past Bolse station is also well defended, your squadron will have a good chance of breaking through there.



TO AREA 6 PG. 100



TO BOLSE PG. 56

Mission 14

300 hits

AREA 6



Area 6 is the Cornerian Defense Force's

military designation for the most heavily defended sector of space around the planet Venom. We believe it is actually the most effective attack point to strike at Andross's palace, which would explain the heavy defenses. Our forces simply do not have the strength to punch through these defenses, but a small, quick team like yours might have a chance. If you can make it through the defensive cordon here, you'll have a straight attack run on Andross himself!

TO VENOM CHALLENGE



The route through Area 6 is arguably tougher than the one going past Bolse defense station, but it will take you directly to the entrance of Andross's lair, avoiding a lot of the planet side defenses.



RUN THE GAUNTLET

This is the deadliest area of space you'll have entered so far. Andross has called out the rest of his fleet, including several squadrons of heavy cruisers. You can destroy the capital ships, but it will take a dead-eye aim and a quick trigger finger. Hyper-lasers are essential, so try to arrive here with a full load of

upgrades and do your best to keep your wings intact during the battle. Barrel rolls, braking and evasive maneuvers will be your keys to racking up points and keeping your ship in one piece. Pay special attention to calls from ROB 64. Great Fox can offer a lot of crucial support on this mission.



Sensor Data

- Umbra class.....31
- Harlock class.....5
- Zeram class.....12
- Mag Flux.....7%
- ECM Function.....No

Astronomic Data

This area of space has no unusual features, but it is the most convenient atmospheric re-entry point from which to strike at Andross's home base. The legendary battle station, Gorgon, which is equipped with a matter-displacement device, is said to control this area of space.



ENEMY RECON

Umbra Class Stations

Umbra-class defense stations are worth four hits each, so destroy as many as you can. (If you're not worrying about points, though, you might be better off targeting the swarms of fighters instead.) Hit them with a charged laser and follow with rapid-fire lasers. Be careful, as some of them will turn and bring all of their guns to bear on you.

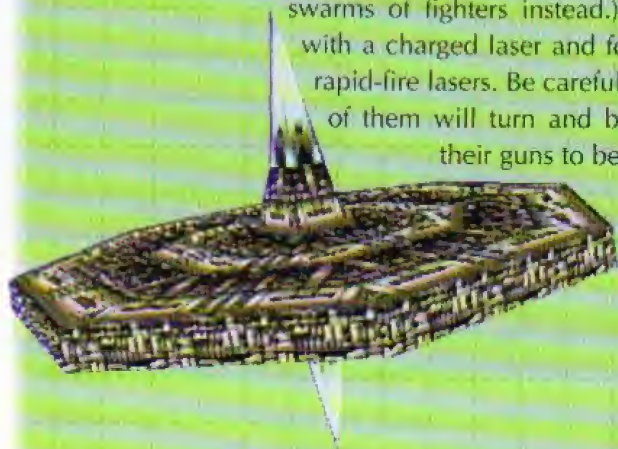

Ninjin Missiles

Though not as powerful as the Copperheads, Ninjin missiles are formidable weapons, nevertheless. They're faster, more maneuverable and tougher to hit than their larger counterparts. Even if they don't connect, the concussion will punch right through your shields. On the other hand, if you destroy one, you might receive a Supply Ring in return.

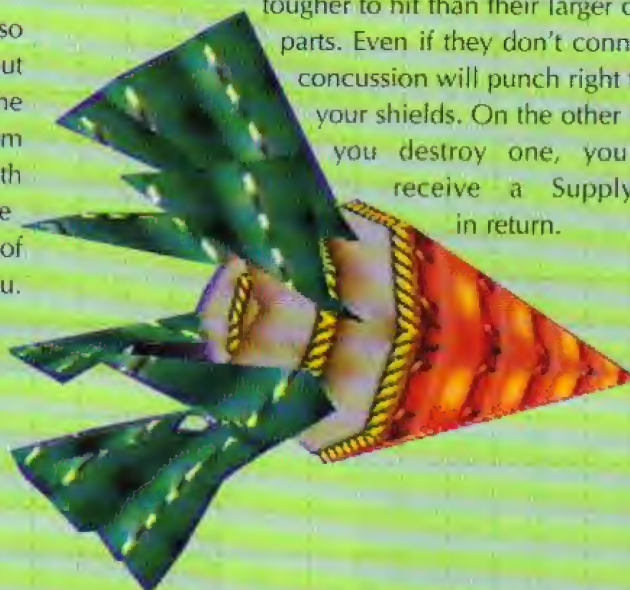

Harlock-Class Frigates

Harlock-class assault frigates are sleek, fast and deadly. Their numerous turbo lasers give them the firepower of much larger ships, but if you penetrate their defenses, you can take them out. The ship's designers sacrificed significant amounts of armor plating for more speed. Just a few shots from your lasers should penetrate their hulls.



Zeram-Class Cruisers

Zeram-class heavy cruisers are the largest capital ships in the Androssian fleet. They are heavily armed and armored, and they're very tough to shoot down with a single laser. Target their bridges (the high, wedge-shaped structures), to destroy them. They're worth a total of six hits each. Shoot their guns separately to rack up extra points.

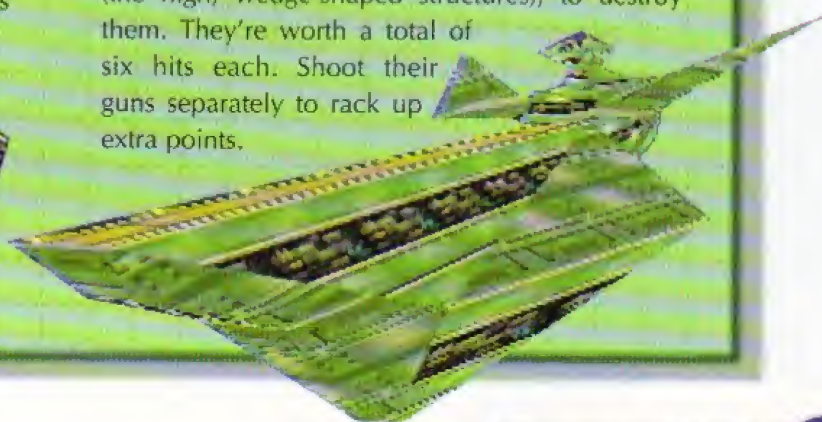

1 TAKING UMBRAGE



The Umbras can absorb a lot of laser fire before being destroyed. Wait for the "Hit+3" message to appear before you move on to the next target. Even if you're a crack shot, it will be nearly impossible to destroy them all.

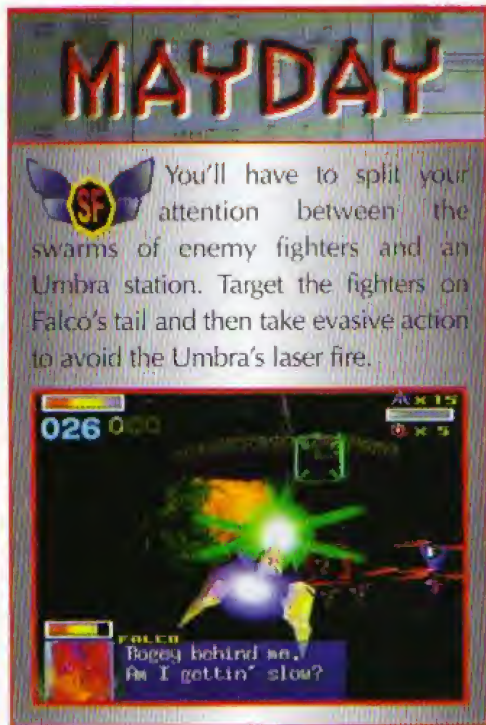

You'll have to split your attention between the swarms of enemy fighters and an Umbra station. Target the fighters on Falco's tail and then take evasive action to avoid the Umbra's laser fire.

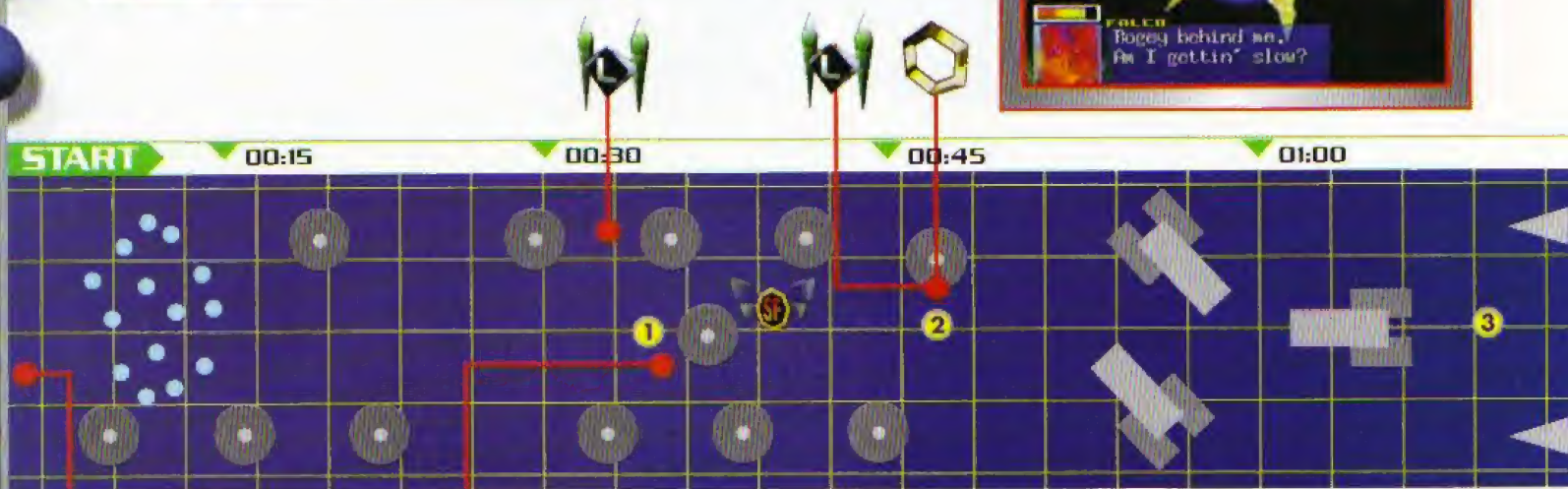

2 TRICKY LOOP



Destroy the entire first squadron of fighters for a sorely needed Laser Upgrade.



Avoid the Umbra's fire and take out the five bug-shaped fighters for a bomb.



This Umbra seems to be dormant, so you don't have to worry about getting shot at. To collect both the ring and the Laser Upgrade, swoop down toward the ring and then pull a loop just as you reach it. You risk hitting the underside of the station, but the ring should help offset any damage to your ship.

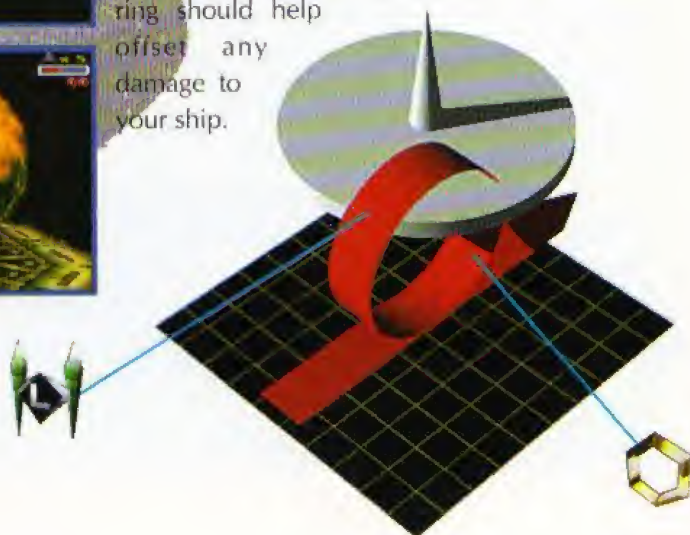

3 ALL LASERS, FIRE!

The Ninjin missiles are tracking you and your squadron. Your best chance to destroy them is with well-aimed rapid fire or charged lasers. Depending on your ship's condition, you may receive Supply Rings.

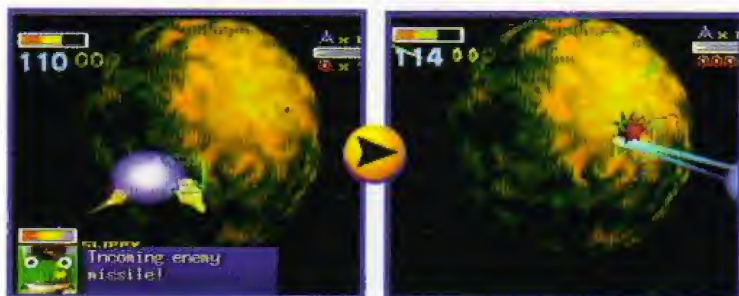

Blast the Killer Bee and get a Shield Ring reward.



If you destroy the first bee in time, another will appear here. Take it out!

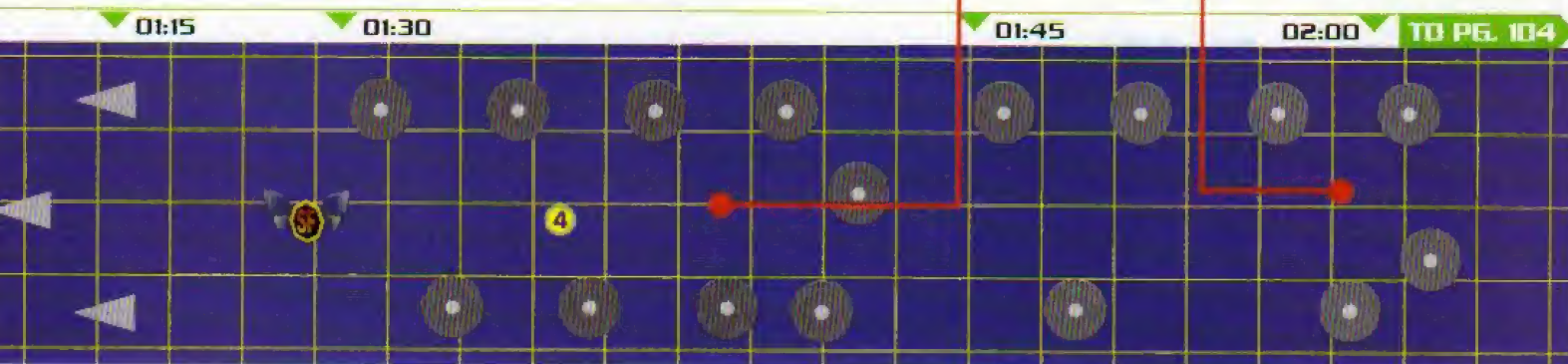

MAYDAY

Peppy is being chased down by an entire pack of heat-seeking missiles. If you don't want to lose him, forget the Umbras and fighters and go after the missiles. If you miss, he may have to sit out the rest of the battle.

4 ANDROSS ON LINE 1



That's not ROB 64 on the com-link, that's Andross! The vile monkey has tapped into ROB's subspace frequency just to taunt you. Since you're busy with a squadron of fighters (hit them with charged lasers, by the way), just ignore his hail.



Andross is crowing now, but wait until you break through his fleet and blast open the front door to his palace!



LOCK ON

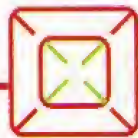

STAR WARRIORS

These Venom fighters are using a new tactic: linking together to form a star-shaped mega-fighter. This gives their weapons far greater range and power than usual. Take them out with two charged lasers or one bomb. The payoff is a Laser Upgrade.



1 TARGET LOCKED

Zeram-class cruisers can be worth up to 19 hits apiece. Blast all the ship's cannons for 13 hits and then target the bridge to destroy the ship itself for 6 hits.

Normal lasers seem to work best on the bridge area, but a Zeram can take a lot of punishment, so work fast.

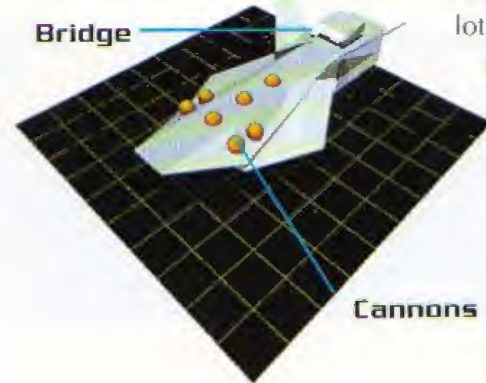

2 CALL FOR BACKUP

Cruisers on intercept course! You must take out the first trio on your own, but Great Fox can get into position to help with the second wave. Target the guns on the cruiser at the head of the second wave. If ROB destroys this ship, you'll get credit for the ship, but not its guns.



MAYDAY

Destroying all these targets will take a perfect aim and expert flying. Lock on to the Butterfly fighter chasing Slippy and then go after either the Zeram's guns or its bridge. You won't have time for both, since there's a flight of incoming missiles that you'll have to deal with, too!



GREAT FOX

LYLAT DATALINK

Developed by Arspace Dynamics Co., Ltd., manufacturer of the Arwing fighter, Great Fox was custom built under the direction of James McCloud. Featuring three NTD-FX9 plasma engines, Great Fox is light-speed capable and has a real-space cruising speed that nearly matches the Arwing's. Power for its two T&B-H9 hyper laser cannons is routed directly from the plasma engines, giving the ship the ability to punch through even a Zeram-class cruiser's shields. ROB 64 was developed in conjunction with Great Fox and is hard-wired directly to the ship's primary computer. James McCloud took out a low interest, 80-year mortgage to purchase Great Fox, a debt that his son is doing his best to repay.

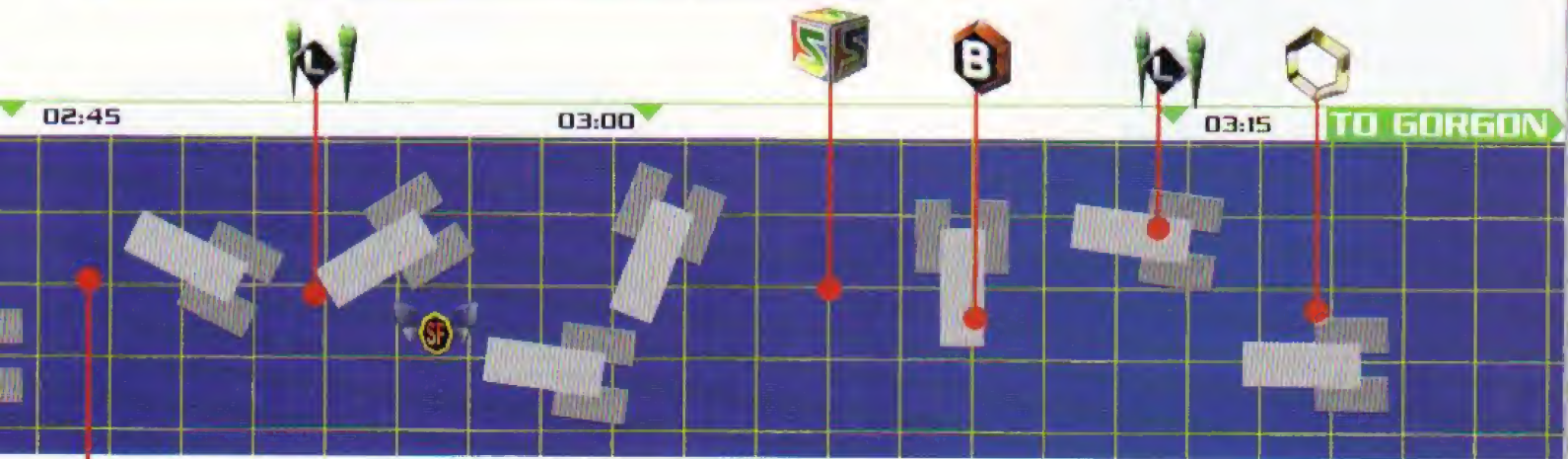

B

GORGON

Gorgon is Andross's deadliest weapon yet! It's equipped with a huge hyper laser capable of piercing the crust of a planet in a single shot. It also possesses a Dimension Transport System that enables it to phase in and out of our reality, something that scientists have thought to be impossible, up until now.

Outer Hull

Gorgon is protected by a laser-resistant armor that even your weapons can't pierce. While the shell is closed, only Gorgon's tentacles are vulnerable.

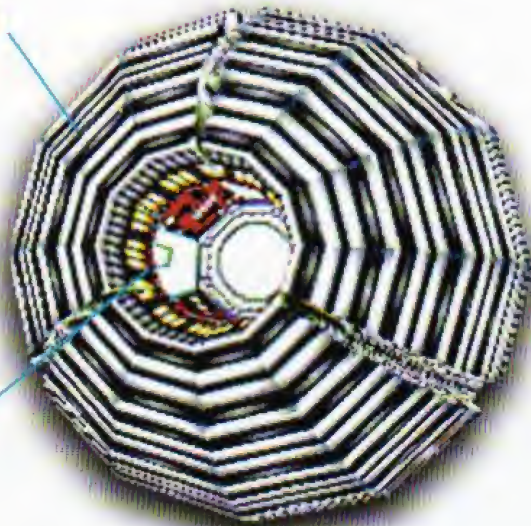

Laser Core

When the armored shell opens, the core of the planet-killer is exposed. If you destroy the three energy balls several times, the core will eventually become vulnerable.



Destroy the tentacles to make Gorgon open its armored shell and then destroy the energy balls. Blast the missiles and fighters for Supply Rings.

After you destroy the energy balls twice, the laser will open fire. Barrel roll around the edge of the screen to dodge.



Keep shooting the tentacles and energy balls. Eventually, the core will be exposed and vulnerable. Hit it hard and fast!

Mission 15

200 hits

VENOM



Fox, we have very little information about the mysterious planet of Venom.

Andross has undoubtedly built a base of maze-like tunnels going deep into the planet. Because his base is hewn from solid rock, there is no way for us to learn anything about it from orbit. At this point, you'll be up against the most elite of enemy forces. The Star Wolf team is sure to show up, and I wouldn't be surprised if they were flying the most advanced ships in Andross's arsenal. This will be your last battle before you go up against Andross himself, so be prepared to fight hard!

1 FROM BOLSE CHALLENGE



If you approach Venom from the Bolse satellite, you must travel over the surface of the planet, through the heart of its defenses, to reach the entrance to Andross's palace.

2 FROM AREA 6 CHALLENGE



If you approach Venom from Area 6, you'll be in line to enter the planet's atmosphere just above Andross's stronghold. You won't have to face entire armies to reach the palace, but it won't be totally undefended.



THE LAST LINE

All your hard work and dedication have brought you to this, the final showdown with Andross. Depending on which path you took to get here, you'll enter either a Corridor mode or an All-Range Mode battle. In the Corridor battle, be especially wary of enemies coming from behind and be ready

on the booster and the brakes at all times. In the All-Range battle, you'll face the Star Wolf squadron in an aerial duel. There will be few items, so don't take big risks. If the radar shows someone on your six, don't wait until the lasers are bouncing off your canopy before you take evasive action.



Planetary Data

- Radius.....8,529 skm
- Albedo.....0.52
- Gravity.....1.43
- Esc Velocity.....14.84 skm/s
- Equilibrium K.....188
- Atmosphere.....N243·CO236·CH412
- Hydrographics ..0%
- Biomass.....0 Quads
- Class.....U

Planetary Compendium

Venom is a harsh frontier world on the periphery of the Lylat system. The atmosphere is almost unbreathable, and the rocky surface is broken by rough cliffs and chasms. Because of its distance from Corneria, it has never been fully explored.

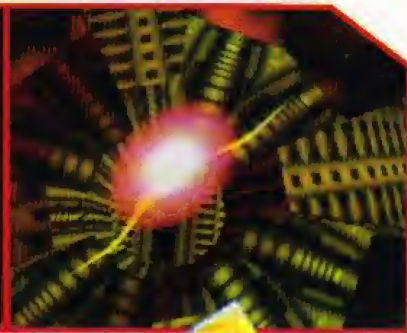

ENEMY RECON

Wolfen II

Your rivals' signature ship has been upgraded in every area. It packs dual lasers, an improved G-diffuser unit and anti-bomb shielding as standard equipment, and this version is also far more maneuverable than the original. The Wolfen II is technically superior to the Arwing, but you can prove that heart and guts count for more than speed and steel!



Blocker

Using portable versions of the Dimension Transport System used on the Gorgon satellite, these blocks will pop up out of nowhere and fill up one of the paths to Andross's palace. You'll be able to squeeze between them, but it will be a tight fit, and your G-diffuser generated shields won't protect you if you run into them.

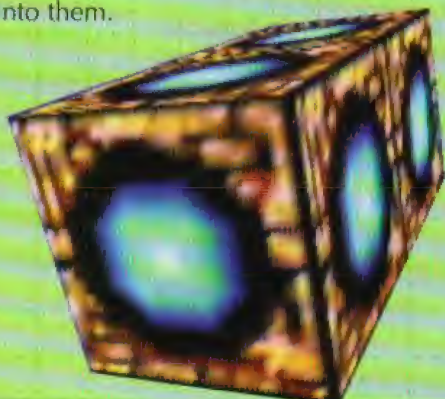

Pillars

Andross has transformed the planet into one, giant booby trap. Taking advantage of Venom's rugged terrain, Andross has rigged the canyons surrounding his palace with pillars of rock that will burst out of the ground if an unauthorized ship approaches. Brake and barrel-roll to avoid them.



Monument

These mysterious monuments are located just outside the entrance to Andross's palace. While some intelligence analysts believe they were built recently by Andross's slaves to honor their master, other experts note that they appear to be very old—ancient, in fact. A detailed analysis has not been possible, of course, but we may learn more after the battle.



CANYON RUN

Now that Bolse has been destroyed, head to the surface immediately. You'll avoid the large capital ships, but planetside defenses have been alerted, so be ready! The surface of Venom is crisscrossed by canyons crammed with the cream of Andross's forces. Great Fox's sensors have mapped out the various paths you can take. There are many paths, but they all lead to the same thing...Andross!



You can follow Falco to the left, but try not to shoot him in the exhaust pipe! Tripods fill the sky.



There are only a few tanks and a couple of incoming squadrons—easy pickings for your lasers!

START

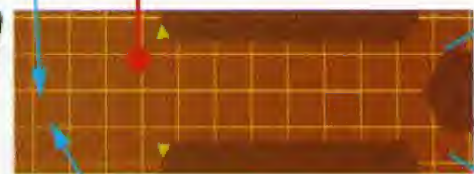
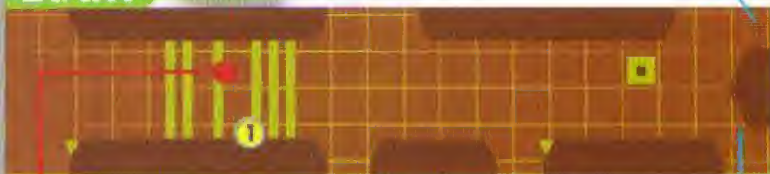

Stay high along this stretch. You'll have fighters ahead of you, and Tripods will be coming in low from behind.



1 STUNT FLYING

Fly down the middle of the canyon and avoid the rock poles that cross from one side to the other. After the third pole on the lower level, dive down to the canyon floor. When you reach the ring, pull a loop to snag both items.

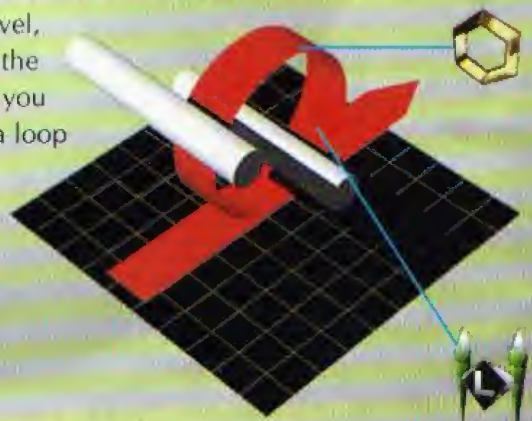

They're trying to distract you with a sea of ground-pounders while Scout Pods drop in from above. Evade!

FLIGHT LOG



A few tanks dot the beginning of this canyon, but catch all the Tripods down the line for a Laser Upgrade.



Andross strapped anti-grav packs to stone columns and is driving them at you from all directions! Brake and roll!

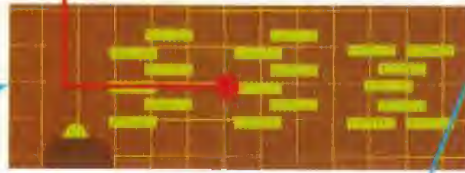

Sensors show fighters posted at both ends of this canyon, and there are stone pillars to worry about, too.

Use a bomb here as soon as you can. For every dragon you destroy, you'll receive a bomb in return.



You can't destroy the energy conduits, but you can hit the Tripods hiding among them.



TO GOLEMECH PG. 110

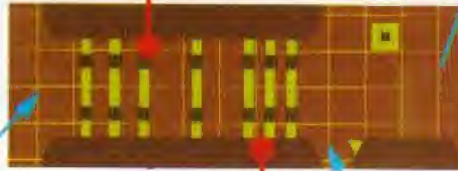

All is quiet here, relatively speaking. If you take out the squadron emerging from that bay, you'll be home free.

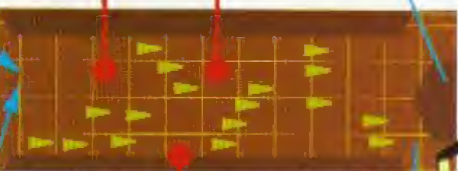

Hit the booster to grab the Shield Ring before the pillars pop out. Sounds like ROB is trying to hail you, too.



Your wingmen are blasting one of the columns so they can slip through. You can fit through the columns, but just barely. Fire your lasers as a guide.

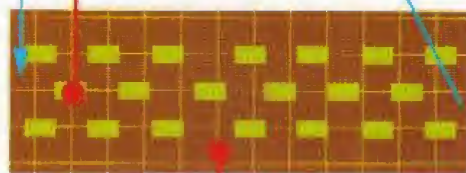

The Venom fighters aren't the only threat here. Blockers are popping up, and two squads of tanks are rolling in from behind!

GOLEMECH

Golemech's rocky armor provides a high degree of protection from lasers. Without hyper lasers, this battle could take some time. Destroy Golemech's body armor first, then go for its head and then the exposed power coupling on its back. Watch out for the pillars of rock that burst out of the walls and the falling columns.

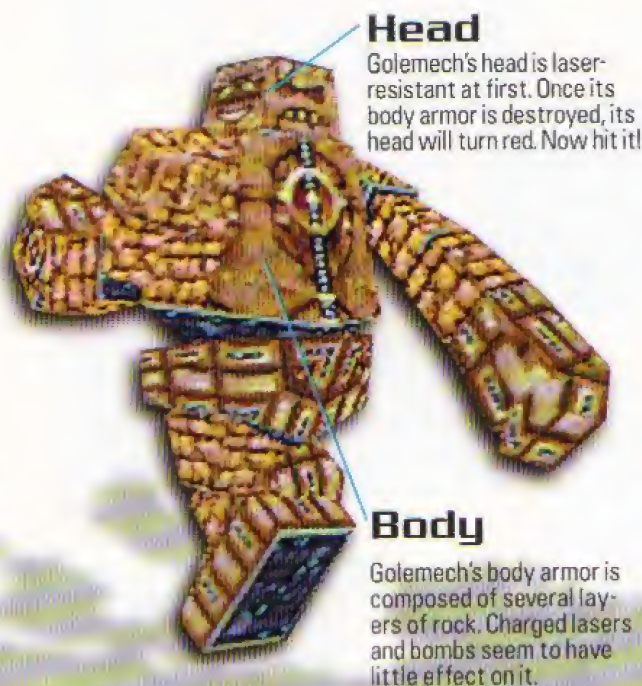

Head

Golemech's head is laser-resistant at first. Once its body armor is destroyed, its head will turn red. Now hit it!

Body

Golemech's body armor is composed of several layers of rock. Charged lasers and bombs seem to have little effect on it.



Golemech will strike the walls, making pillars burst out and fall. Keep your distance to avoid getting hit.



You won't be able to defeat Golemech until all its armor is destroyed. Concentrate on one area of its body and then move on.

TO ANDROSS PG. 112

Golemech was the last line of defense! Now follow the tunnel to Andross's lair. You can shoot the laser emitters or avoid the barriers they create. Don't worry if your battle with Golemech damaged you. You'll find lots of items along this tunnel.



LYLAT
DATALINK

EVIDENCE OF A LOST TRIBE?

It is not known whether Golemech is something Andross created or something he discovered in the ancient ruins that dot the surface of Venom. Few archaeological surveys were sent to Venom before Andross took it over as his base, but Corneria University scientists believe that

the legendary Lost Tribe of Cornerus did, indeed, inhabit Venom in the distant past. They also think it possible that Golemech is a remnant of the Lost Tribe's technology. Ancient texts state that the tribe eventually struck out into space to find a new home, but what became of them, no one knows.

FROM AREA 6

You've broken through Area 6, giving you a straight shot at Andross's palace, but you can't relax yet. Star Wolf and company are out for blood—yours!

STAR WOLF

This is the final showdown between you and your longtime rival. If not for Pigma's influence, you may never have become enemies. Who knows? In another time, another place, you might have called him friend...

Wolfen II

The Wolfen II's improved G-diffuser design gives it better protection and maneuverability than your Arwing's. It will take a lot of shots to bring it down.



If your Shield Gauge drops too low, ROB 64 will contact you for a resupply. If you respond, the Supply Container will appear in a random spot.

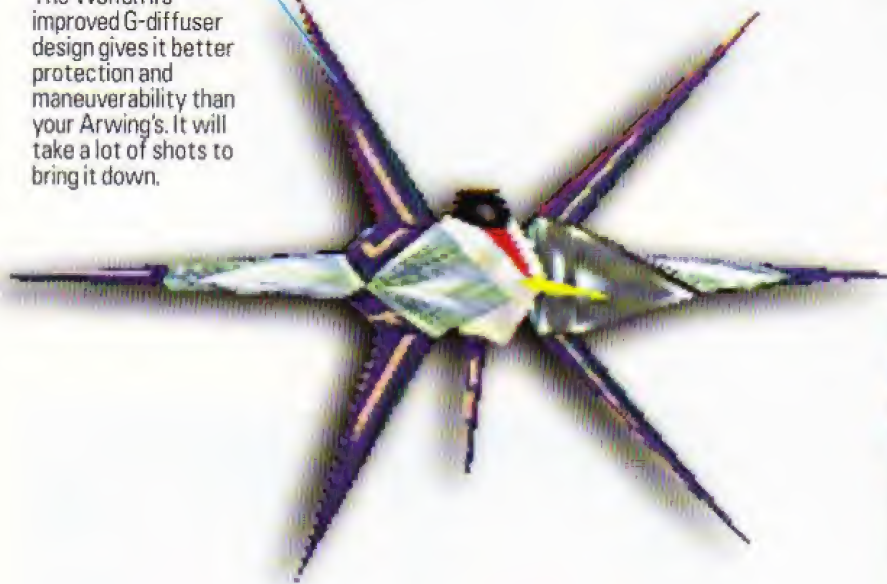

The key to this battle is visibility and maneuvering, so switch to the wide-angle view. Pull a loop to turn the tables on a pursuer. Turn tightly to stay on his tail.



TO ANDROSS PG. 112

Star Wolf was just a puppet, and now it's time to go after the one who pulled his strings—Andross! Follow the map, but avoid the sharper turns or you'll lose a wing.



START

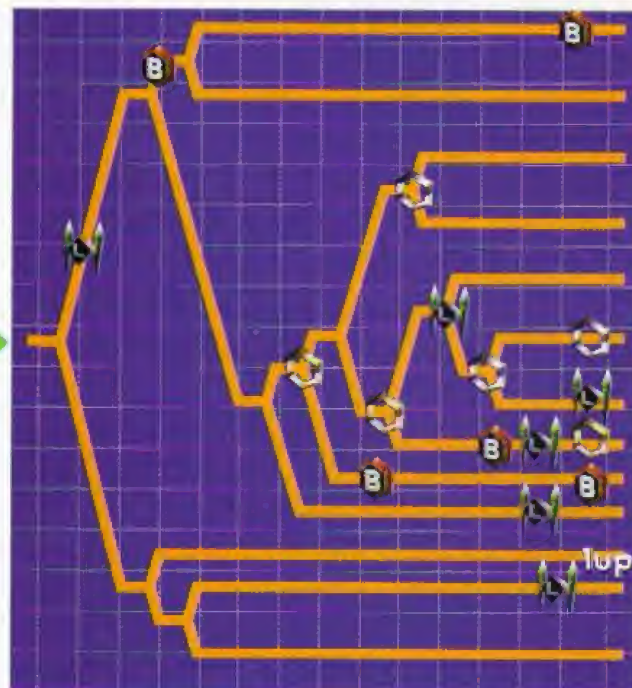

TO ANDROSS

ANDROSS

The key here is to destroy Andross's hands first and then his head. There are several ways to do this, but here's our preferred method. Shoot him in the eyes to distract him and then shoot his hands. Be ready to dodge the lightning bolt he shoots from his right (his right, your left) hand. Repeat until both hands are gone.

Eyes

Shoot his eyes to distract him. It won't really hurt him, but it will make him pause.

Hand

Andross can fire lightning bolts with his right hand only, so destroy it first. If you miss shooting him in the eye, instead of trying to blast you, he'll try to punch you several times and then try to suck you into his mouth.

Head

Once Andross's hands are destroyed, his head will be vulnerable, but only at specific times: after you launch a bomb into his mouth and he laughs, or after he spits a mouthful of rocks.

Mouth

If he tries to inhale you, launch a bomb into his mouth and then blast him between the eyes. If you don't have a bomb, turn and brake to escape. When he spits, shoot the rocks and then his face. If he inhales you, he won't be vulnerable when he spits you out.



Andross will throw a low left punch, a middle left punch, a low right punch and then clap his hands together. He'll then try to inhale you.



When Andross spits, blast the rocks. If you're lucky, you'll receive bombs and rings in return. In fact, once the hands are gone, you can prolong the battle to stock up on weapons or recharge your shields. You'll wear Andross down eventually, but his head will explode to reveal an even more sinister form!

FROM BOLSE

Why, it's not Andross at all, but some robotic duplicate! In any case, it's going down hard. Shoot it between the eyes. You can't dodge as it charges at you, so let's hope you have some power left in your Shield Gauge!



FROM AREA 6

All that's left are Andross's eyes and brain, grown to monstrous proportions. The brain is so large, it can't maneuver up and down as much as you can within this All-Range area. It's equipped with a Dimension Transporter and powerful thrusters, though, so it will still be tough to get it in your laser sights. Using the radar scope will be crucial to lining up your shots.

Eyes

The eyes are connected to the brain by energy strands. Concentrate your fire on the eyes first. You can't disrupt the energy strands, but they can hurt the Arwing.

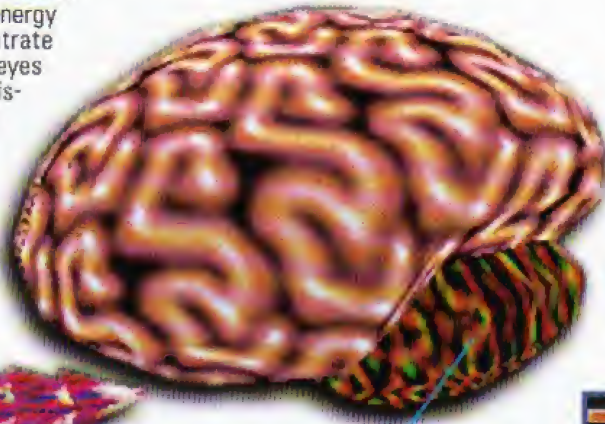

Medulla

This structure at the base of the brain is its weak point. It releases bulbs of explosive energy, and it also has tentacle-like strands that can pull you in.



The eyes show up as dots on the radar. Loop around and shoot them from behind. Try to avoid the energy strands as much as possible.



After the eyes are destroyed, go after the brain. If you shoot the main portion of the brain, it will use its Dimension Transporter to get away.



Stay low. Get behind the brain and turn in the same direction it's going. Brake and barrel-roll to turn as tightly as possible. Shoot the weak point when it comes into view.

ESCAPE FROM VENOM

Andross's dreams of conquest are going up in nuclear fire, but his death throes are also overloading your shields. It looks like you won't live to enjoy your victory after...wait! What's that? It's another Arwing, but who's at the controls—James McCloud?!

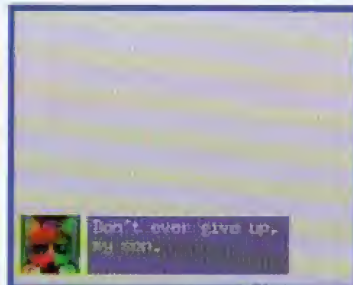

It can't be true, but it is! Fox's father has come to show him the way out of Andross's palace. Engage the booster and follow him through the tunnels.



Use the booster on the straightaways, but ease up before you get to a fork. James McCloud may turn suddenly, and if you take the wrong path, you're toast.

You made it! Now you can go back to Corneria and celebrate a grand victory and a joyous reunion! Isn't that right, James? James? Where did he go?

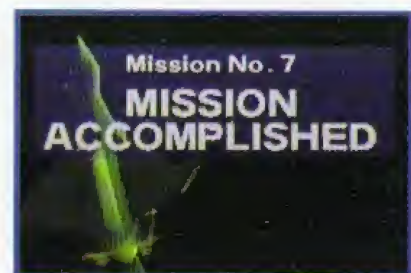

VS. MODE

To supplement your combat training, Arspace Dynamics Co., Ltd. engineers have constructed a Vs. Mode simulator that pits you against your fellow pilots in mock combat. Up to four pilots can participate in a battle, and there are three battle formats to choose from. This is the perfect tool for honing your skills!



FRIENDLY FIRE

The simulated cockpit and instruments are a bit different from a true Arwing's, but flight and weapons control are exactly the same as the real thing's. The split screen allows up to four pilots to participate. If there are fewer than four pilots in a battle, the extra screens will display the action from various angles. You can customize certain features before a battle, and you can choose from two out of three battle sites, depending on which type of match you've selected.

HANDICAP

This option allows novices to challenge experts on equal footing. The higher the handicap, the less shield energy you have when the match begins.



ITEMS

Laser Upgrades and Smart Bombs are available in Vs. Mode. They appear as white dots on the radar screen. Defeated vehicles turn into items.



FLY/DRIVE

Once certain conditions have been met (see page 120) you'll also be able to select a Landmaster tank and a hologram of yourself armed with a bazooka!



POINT MATCH

Combatants agree on a number from one to five and enter it into the computer. The first one to defeat that many vehicles is the winner. If you're defeated (and no one has won yet), you reenter combat in a new vehicle.

BATTLE ROYAL

This is a "sudden death" match in which each pilot is given one vehicle. If you're defeated, you're out of the match. The last surviving pilot is declared the winner.

TIME BATTLE

In a Time Battle, the computer clock is set for anywhere from one to five minutes. The pilot with the most wins at the end of the period is declared the winner. If you're shot down, your tally of wins is reset back to zero.



VS. MODE TACTICS

BREAK THE LOCK

In Vs. Mode, if an opponent gets a target lock on your vehicle, you'll hear a warning beep, and your ship will be tagged with a red cursor. Pull a loop or a U-turn to break the lock.



WRAP AROUND

In Vs. Mode, the battlefield is a continuous loop. If you fly off one edge, you'll reappear on the other. Pilots often forget this fact, so use it to surprise opponents.



CORNERIA

This battle site is modeled after a typical urban area on Corneria. The buildings aren't grouped tightly, but they do provide cover from enemy fire. There are items hidden among the arches and other structures (marked by the stars on the map), so you'll also be able to practice stunt flying and emergency maneuvers. If you choose to drive a Landmaster, the pyramids are good shields against aerial attack.

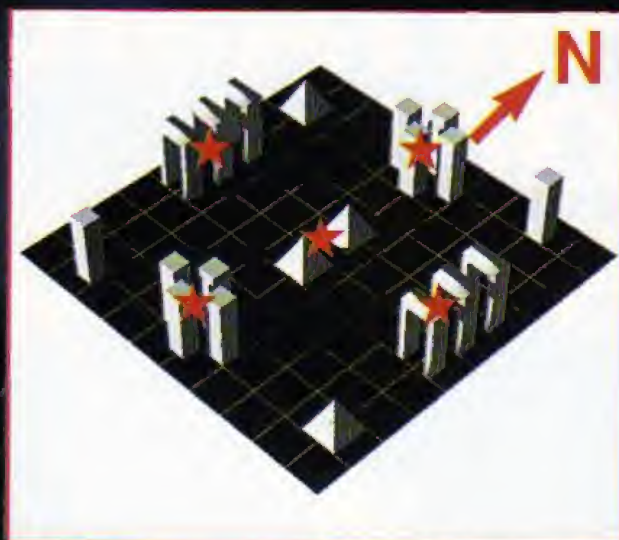

SECTOR Z

This next battle site is modeled after a portion of the Sector Z space junkyard. The arena is very tall, and you can climb, dive and perform complex maneuvers without worrying about smacking into the ground. Flying through the debris in the corners is hazardous, but that's where you'll find Laser Upgrades and Smart Bombs. Of course, Landmasters and characters aren't available here.

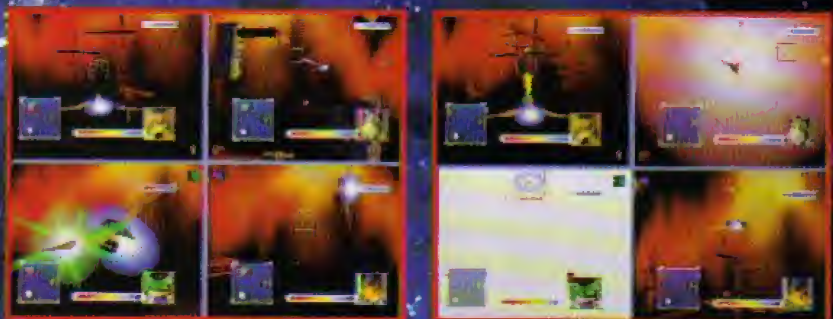

KATINA

The Katina battle site is available only in a Time Trial. Except for the central Katina base pyramid, the arena is wide open, leaving Landmasters and characters with little useful cover. This is where wits and ability will count the most. Keep an eye on your radar screen at all times. If you're in an Arwing, remember that you can see ground units only if you're fairly low and close to them.

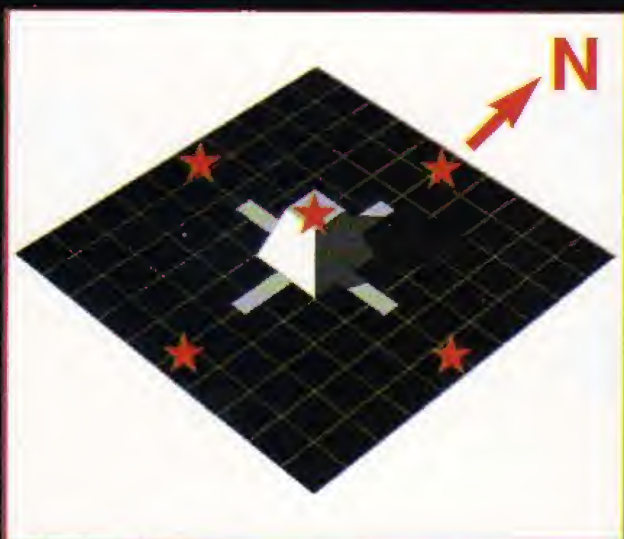



MIYAMOTO ON STAR FOX 64





In an exclusive interview with Nintendo Power for the Star Fox 64 Player's Guide, Shigeru Miyamoto discussed the creation of Star Fox 64 and other related topics from his office at Nintendo's Kyoto headquarters. If you ever wondered where the Star Fox idea came from, or what the premier game designer in the world thinks about when he's making a game, then read on. You might even find out what Star Sheep is all about.

TOPIC: THE GOALS FOR STAR FOX 64

 We heard that you did the job of the director even though officially you were the producer of Star Fox 64.

 (Laughing.) No, it's not true. Since I designed the original Star Fox game, I am responsible for the basic game design, but I fully relied upon other people to direct the game.

 We also heard that you had many opinions about how to change the Corneria stage, especially after the game was finished.

 Yes, I asked for additional changes to add more excitement. I wanted to see changes to some of the basic rules, as well.

 How about map design?

 I made changes in Corneria and Meteo. I think that the first 30 minutes of a game is the the most important. It's the producer's job to make sure that it's exciting.

 Why did you make Star Fox 64 a remake of the original Star Fox?

 We wanted to produce an interesting game design rather than a new story. Sometimes I ask myself if we should continue this approach. For example, should we keep trying to put all

the new technologies into each new Mario game. What comes next? Super Mario 128? Actually, that's exactly what I want to do (laughs).

 We saw Star Fox 2 for the Super NES several years ago, but it never came out. Did you use any ideas from that game in Star Fox 64?

 We borrowed several ideas. All-Range Mode, Multi-Player Mode and the Star Wolf scenario all came from Star Fox 2. I'd say 60% of SF64 comes from the original game, 30% from SF2 and 10% is entirely new.







 So you really wanted to make the definitive Star Fox game with the N64 title?

 Not exactly. I'm not so attached to the Star Fox theme. The original game was a challenge to push the limits of the [Super NES] hardware. When we showed the game to people, they said, "Uh, what's that triangle?" For us the polygon shapes were part of a ship or a building, not just a flat triangle. Now, after finishing Star Fox 64, I can look back and see that it really was just a flat triangle (laughs).

 What were some of the things that didn't work in the original game?

 I really wanted to make realistic aiming and shooting—sort of a floating feeling. But it was difficult to get it to work on the Super NES. I wanted to improve that in the N64 game.

 Now the Arwing control is remarkably smooth. Did you want to include more special moves than the loop and U-turn?

 If we make another Star Fox, we'll probably add a move and delete a move. I don't want the play control system to be too complicated. The Arwing has to be able to do a lot in a dog-fight without an overly complex control system. Maybe the current system is pretty close to ideal.

 The configuration of the button controls always seem to be very good in your games. How do you decide what button operates what function?

 I had a problem with the placement of the boost button in this game. I thought it might make more

sense to use the top C Button, but if you put the camera control on the left C Button, then players wouldn't accidentally hit it and shift their view. I tried many alternatives, but I'm satisfied now with the final arrangement.

 You must be happy with it. You didn't include a configure mode.

 Actually, we kept the configure mode until the end of last January, but we decided that we should emphasize Star-Fox-like game play and we deleted the option. Also, we wanted to establish a sort of standard for Control Stick operations.

 With most games, you have said that you begin design with an experimental core sequence. Did you do that here?

 Since we began with the idea of converting the original Star Fox, we didn't have to do any experiments. Shaping up the graphics was one sort of experiment, and discovering how many enemy characters we can move with intelligent action was another. Real-time dialogue was also a big experiment when we began this game.

 It seems surprising that Fox has a speaking part. It's hard to imagine player characters like Mario or Link speaking in one of your games.

 Yes, I'm also surprised (laughs). I supervised the script editing, but much of it was entrusted to other staff members. Then I discovered that Fox was speaking. Where did that come from? But, as it turns out, the speaking parts are kept to a minimum. It's different from an RPG character speaking.

 In Japan, some players have complained that Slippy doesn't croak. That is to say, he doesn't make a croaking sound.

 I told them to cut the croaking (laughs). It was too childlike.

MIYAMOTO STATS

Birth Date	11/16/52
Birth Place	Sonobe cho, Kyoto, Japan
Sign	Scorpio
Height	166cm
Weight	64kg
Hand	Ambidextrous
Hobbies	Guitar, Sports
Favorite Game	Pac-Man
Favorite Food	Noodles
Favorite Animal	Dog
Current Pet	Hamster
Hobbies	Family time, Guitar practice

TOPIC: A GAME LIKE A MOVIE

 At the Tokyo Game Show, you talked about how Star Fox 64 is a movie-like game. Could you explain more about this?

 I don't have the exact answer to this. For ten years, people have talked about interactive movies, mainly people in the film industry. Game developers have also tried to make interactive movies, but they usually turn out to be more movie-like than game-like. It seems that a lot of game people seem to think that movies are superior, for some reason, but we don't think that at all. Still, we think that we can borrow good ideas from the movies, like dramatic camera movements and the use of real-time voices. In Star Fox 64, we found that the overall experience gave us a fuller, movie-like feeling. Basically, movies are a passive experience and games are active. I didn't exactly set out to do this, but Star Fox 64 became an example of what I think interactive movies can be.

THE REAL STAR FOX

Fushimi Inari is a famous shrine located about ten minutes walking distance from Nintendo Co. Ltd. in Kyoto. When Mr. Miyamoto decided to use an animal character as the hero for the original Star Fox, the choice of the fox came to him from the statue in this shrine. Inari, the fox, is a traditional god of grain in Japan. When Mr. Miyamoto was courting his wife-to-be, they often strolled through the shrine grounds of Fushimi Inari. Look closely around the eyes of the statue and you'll see a hint of Fox McCloud staring back.



If you visited the area surrounding the shrine of Fushimi Inari, you'd find many reminders of Inari, like the sign by this shop. You'll also find items for sale in the shape of the fox, like the ceremonial mask.



TOPIC: OTHER UPCOMING N64 GAMES



Can you tell us anything about the other games that are in development for the N64?



Right now we are working on GoldenEye, Yoshi's Island 64 and Zelda 64. GoldenEye is being done by Rare. That kind of first-person game makes very good use of the Control Stick, but it's not something we're very good at here at EAD. I'm glad that Rare is working on it. Turok was a good example of that type of game. I appreciated how the developers made use of the hardware in their game design. I even thought about using some similar things in Zelda 64, but we're kind of heading in a different direction on that game.



Using the Control Stick is very important to your plans?



Yes. Zelda 64 will be an adventure that both beginners and experts can enjoy. Intuitive play control is a big part of that, and the Control Stick lets you make very natural feeling moves.



What will you change in Yoshi's Island 64 from the original?



It will be easy to move about, but your use of the Control Stick will determine if you discover new things. You will be able to rotate backgrounds as if you were directing the game. It should be more fun that the original because of the power of the hardware.



And what about Zelda 64?



I'm working full-time on Zelda 64 now. Zelda will be a more realistic, emotional adventure than Super Mario 64. I want players to be able to feel the game. They should be able to feel light and shadow, and even temperature and humidity. With the power of the N64, we can express all of these things. There will be many interactive movie elements in Zelda 64, as well. If I could spend the next two years on this game, it would be unbelievable (laughs).



How soon will we see it in North America?



Conversion from Japanese to English needs a certain amount of time. Perhaps four months after the Japanese version. I would guess that by about April or May next year you will be reading a Zelda 64 Player's Guide.



What are your favorite parts of the game?



Since I'm a father, I like the final stage where James McCloud returns to guide his son, Fox, through the tunnel to escape from Venom. I also like the ending scene at Katina when you have all the allied fighters flying in formation. To get that you have to make sure that you don't hit Bill or any of the other good guys.



TOP SECRET FILE

Seeing that you're spearheading the struggle against Andross, General Miyamoto has ordered that you be given top security clearance for the duration of this campaign. This data file is classified as Top Secret, For Your Eyes Only. Share this information only with those individuals who also have top-secret clearance!



EXTRA MODE

If you win a medal in every mission, you'll enable the Extra Mode. The Extra Mode gives you access to the Landmaster tank in the Vs. Mode, a sound test feature, an interesting trick for your N64 and last, but certainly not least, a set of expert missions. The Extra Mode features will be automatically added to your main menu, and you won't have to do anything special to get to them. The expert missions have the same layouts as the normal missions, but there are more enemies to defeat, and some enemies will be tougher and smarter than before. As a bonus, you'll also notice that a certain dashing young pilot is wearing some very cool shades—much like his father's!



ARWING VS. LANDMASTER

Once you earn a medal in every mission, you'll be able to drive the Landmaster in the Vs. Mode. The Landmaster has the advantage of being stealthy. When doing battle against the Arwing, it will rarely show up on its opponent's radar unless the Arwing is quite close to it.

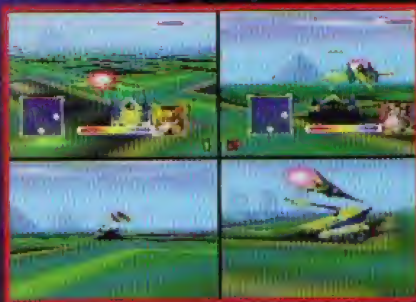

The Landmaster is tough to see from the air, but the ground pounder is obviously not as quick or as maneuverable as its winged cousin.

SOUND TEST

The expert sound test allows you to pick any of the musical themes in the game and play them. An equalizer display allows you to view the sound levels of each piece.



LOGO TRICK

You can move the number 64 on the title screen using the Control Stick. The team will watch in surprise and fascination as you move the number around the screen.



FOX VS. FALCO VS. PEPPY VS. SLIPPY

You can also earn medals in the expert missions, giving first-class pilots some fresh challenges. If you collect another full set of medals, you'll enable one last special feature: the ability to select Star Fox team members in Vs. Mode. Along with spaceships and tanks, you'll be able to pit bazooka-toting animals against each other in combat!



THE LYLAT SYSTEM MAY BE SAFE...

BUT THE GAME'S FAR FROM OVER!



SUBSCRIBE TO NINTENDO POWER.
GREAT FOX CANNOT COVER YOU WHILE YOU ARE
PLAYING OTHER GAMES.

ROB 64'S RIGHT! THERE ARE TONS MORE GAMES TO PLAY, AND WHERE ARE YOU GOING TO TURN FOR HELP? LOOK TO NINTENDO POWER EVERY MONTH FOR THE BEST TIPS, CODES, MAPS, STRATEGIES AND OTHER TOP SECRET INSIDER INFORMATION. IT COMES STRAIGHT FROM THE PROS AT NINTENDO! WHO WOULD KNOW MORE ABOUT THE GAMES YOU LOVE TO PLAY? FOR JUST \$19.95* YOU PICK UP A FULL ONE-YEAR SUBSCRIPTION—AND YOU DON'T HAVE TO FLY TO VENOM TO GET IT. WE'LL ZAP IT RIGHT TO YOUR MAILBOX!

CALL 1-800-255-3700 TO SUBSCRIBE TODAY. ASK FOR OFFER #2555 TO SCORE A REALLY COOL STAR FOX 64 KEYCHAIN FREE!**

www.nintendo.com

*Canadian residents pay \$27.95. Prices are subject to change.

**Offer good while supplies last. Please allow 4-6 weeks for delivery.





HOTTER THAN A HYPER LASER

THE STAR FOX 64 PLAYER'S GUIDE

In space, no one can hear you scream; that's why you need the Nintendo Player's Guide onboard in case of emergencies. When the forces of Andross fill the sky with lethal fighters, that's the time you need the expert strategies straight from the pros at Nintendo Power. With the Star Fox 64 Player's Guide in your flight plan, you'll be in total command of the mission, scoring medals, setting record hit counts, activating warps and discovering secrets known only to the elite fighter pilots of Corneria.



IT'S PACKED WITH:

- Pro tips and strategies
- Complete maps of every stage
- Hot multi-player tactics
- Detailed flight plans for Secret missions

